

HARVIA

+ Made in

Urban sauna cabin - Installation instructions

Mini (URB1212FG and URW1212FG), Medium (URB1616FG and URW1616FG)



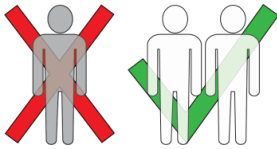

Tools required















Screws

Zn = Zink

X pcs Zn X * X



SCREWS and ATTACHEMENTS

Code	Name	Measure	Amount	Picture
KT101	UNIVERSAL SCREW COUNTERSUNK PART TX25 ZN 5.0X50	5*50 mm	26	
KT040	UNIVERSAL SCREW COUNTERSUNK HEAD TX10 ZN 3.0X25	3*25 mm	14	
KT217	UNIVERSAL SCREW COUNTERSUNK PART TX25 ZN 4.5X50	4,5*50 mm	16	
KT053	UNIVERSAL SCREW COUNTERSUNK PART TX25 ZN 5.0X80	5*80 mm	8	
KT232	UNIVERSAL SCREW COUNTERSUNK SHAFT A2 TX25 6X100	6*100 mm	8	
KT046	UNIVERSAL SCREW COUNTERSUNK PART TX25 ZN 4.5X45	4,5*45 mm	24	
PUUKIILA	Wooden wedge for installing glass		2	
VAPLA9	Plywood piece 40x100x9mm		2	
KTLP1	Glue bag		2	
KT153	Dyckert nail Zn 1,7*45 mm	1,7*45 mm	24	
DEKCLICKMBRB	SPARE PARTS		2	
KT225	Comes with frames UNIVERSAL SCREW COUNTERSUNK PART PZ2 ZN 4.5X45	4,5*50 mm	8	





UNPACK ALL

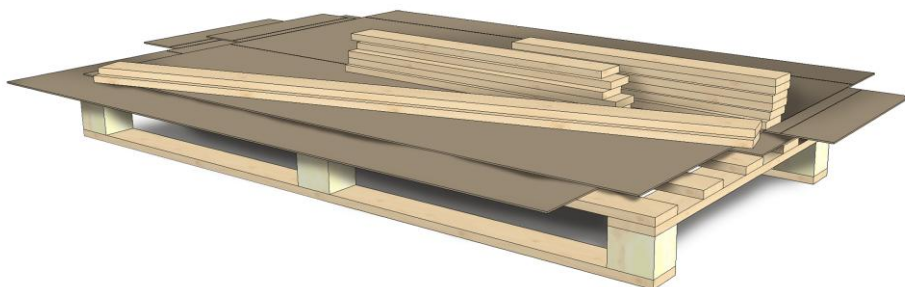
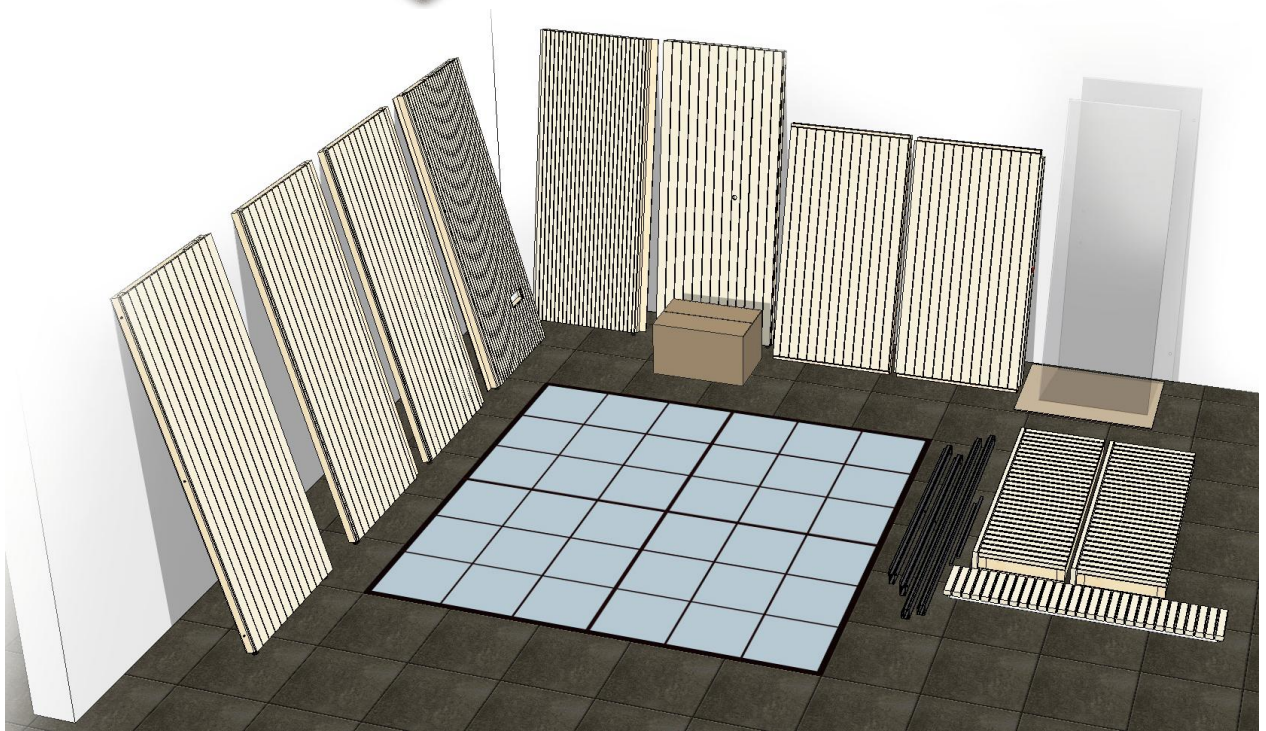

RECYCLE

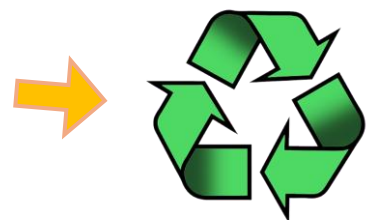

CHOOSE HANDEDNESS

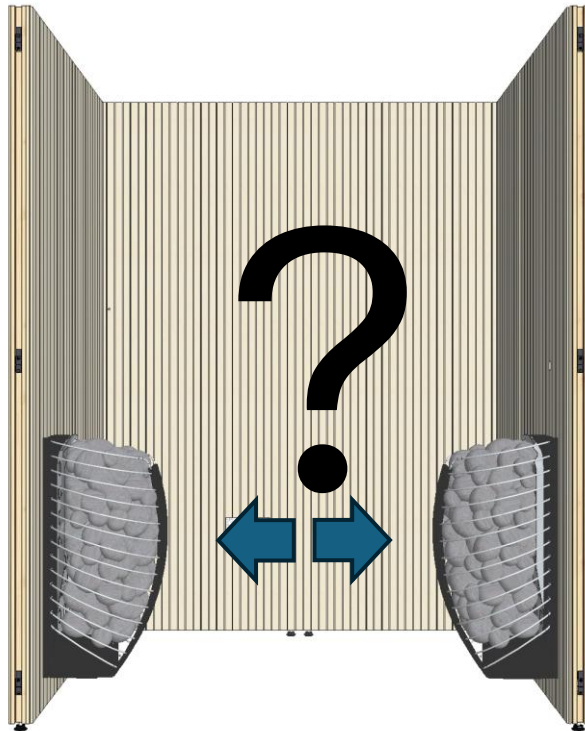

Right handed sauna

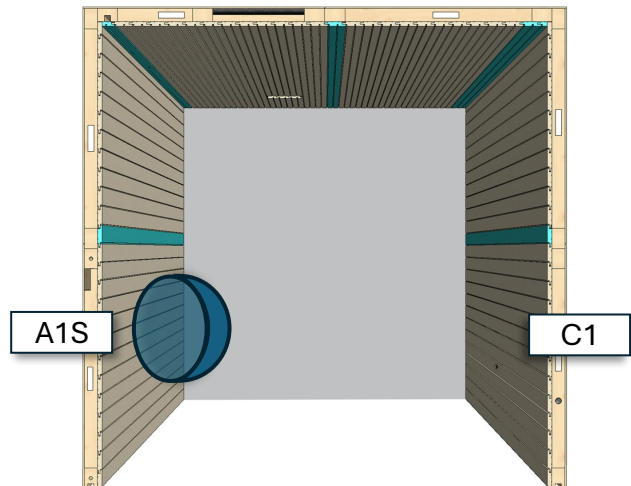
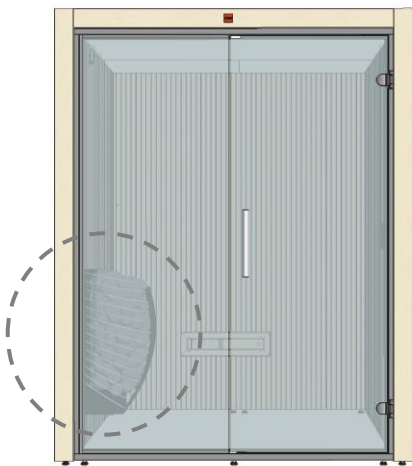

Left handed sauna

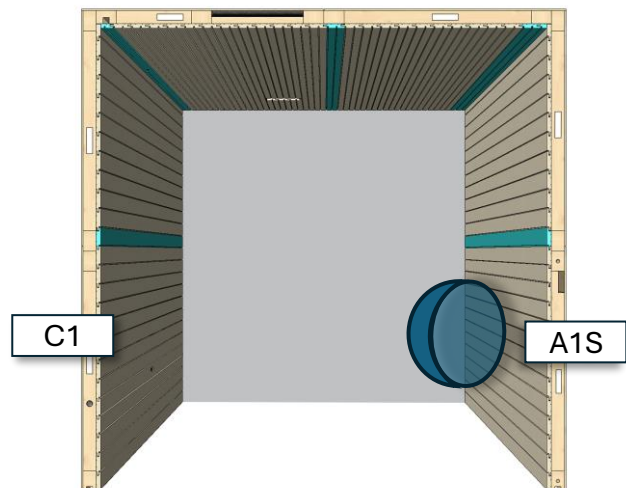
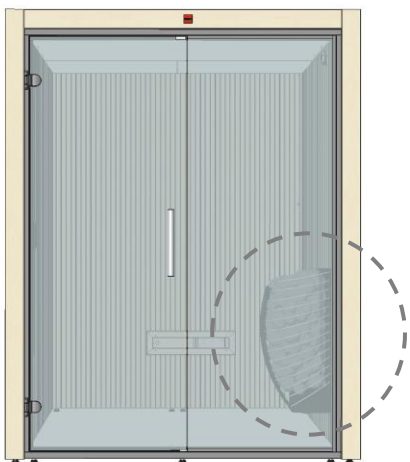

ELEMENTS Note! Size may differ depending on the model

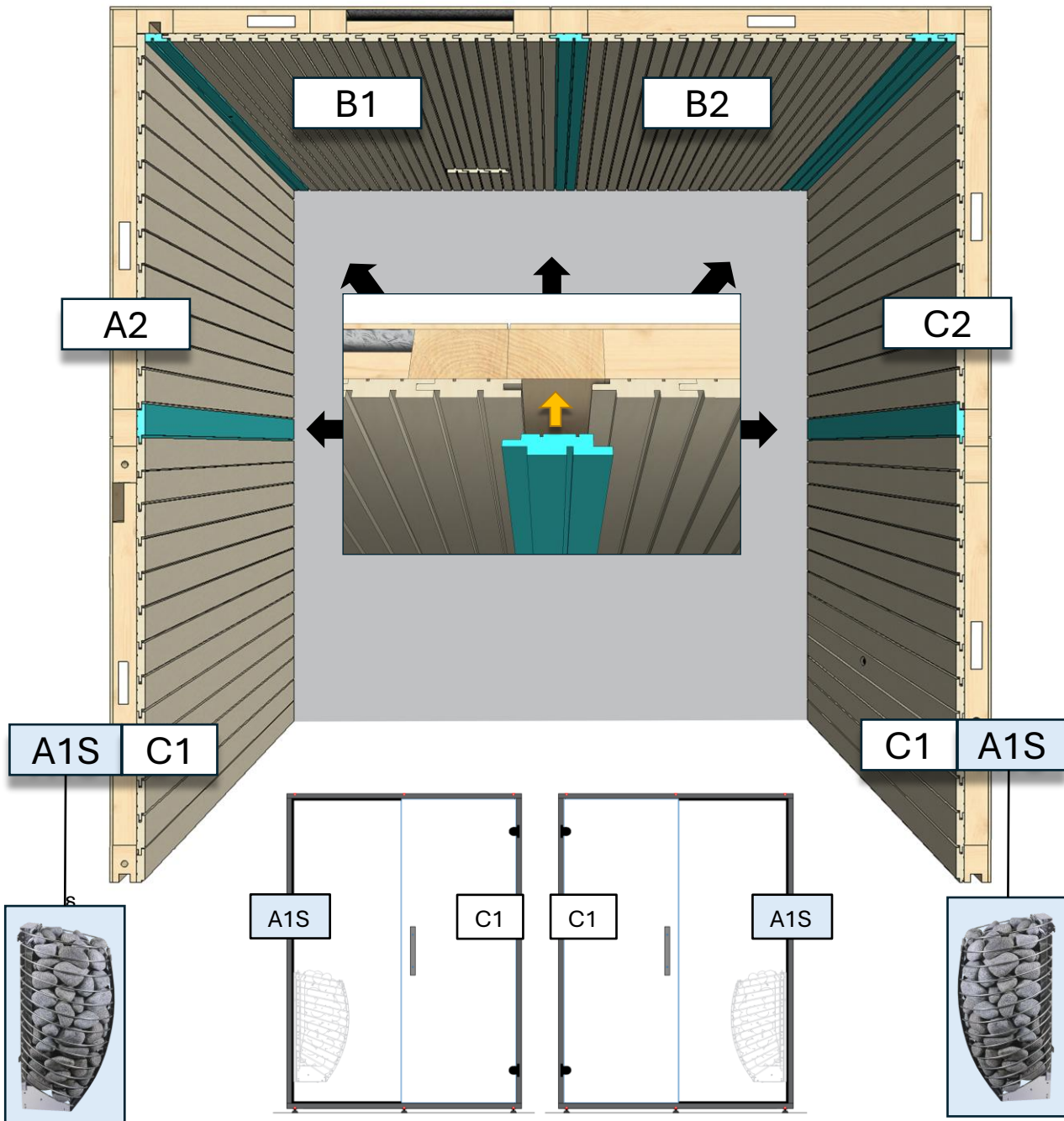
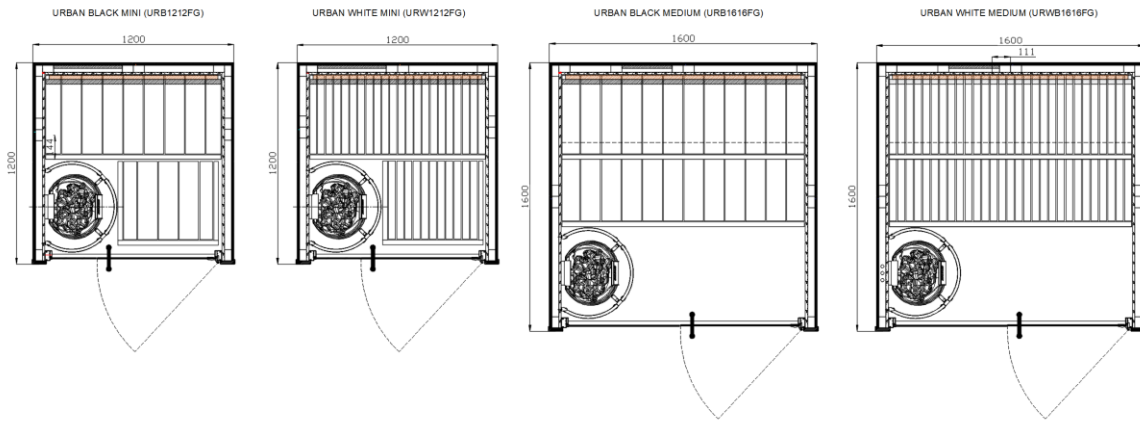



INSTALLATION OF ELEMENTS

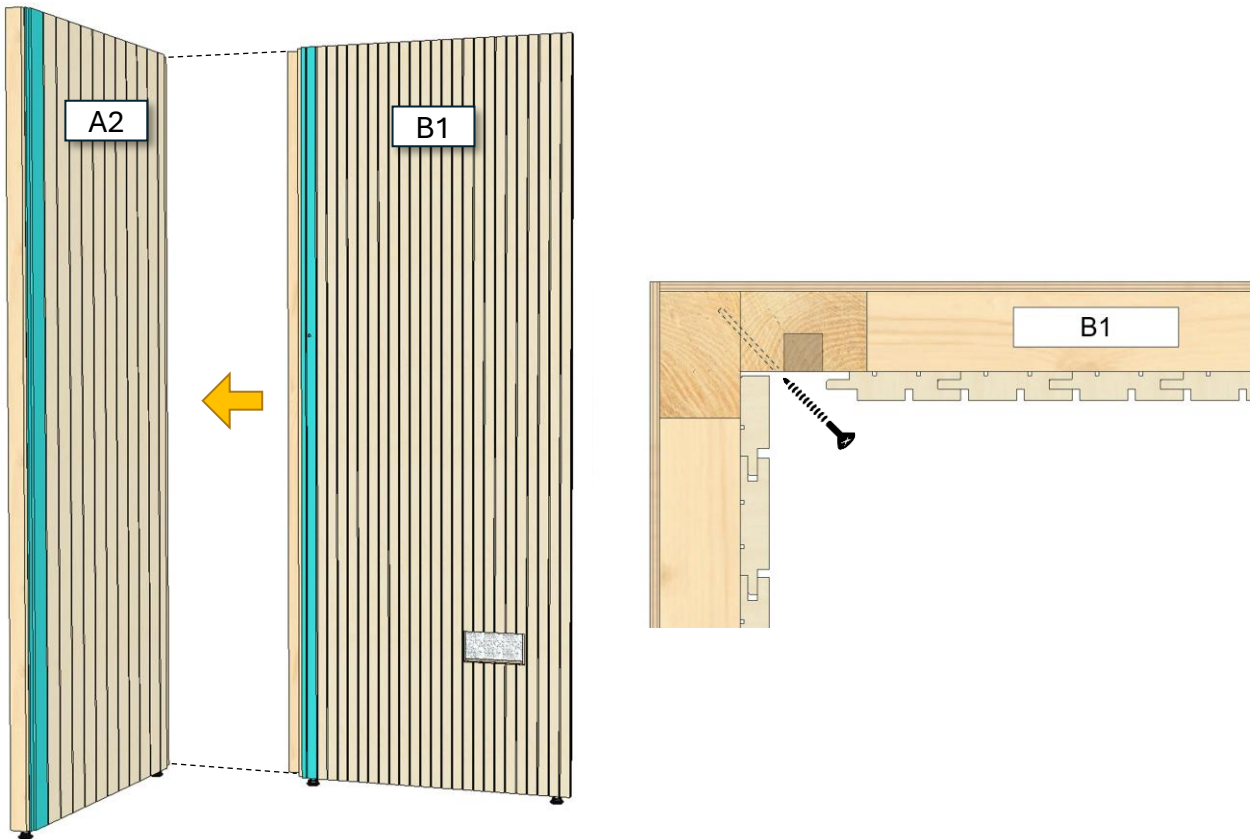
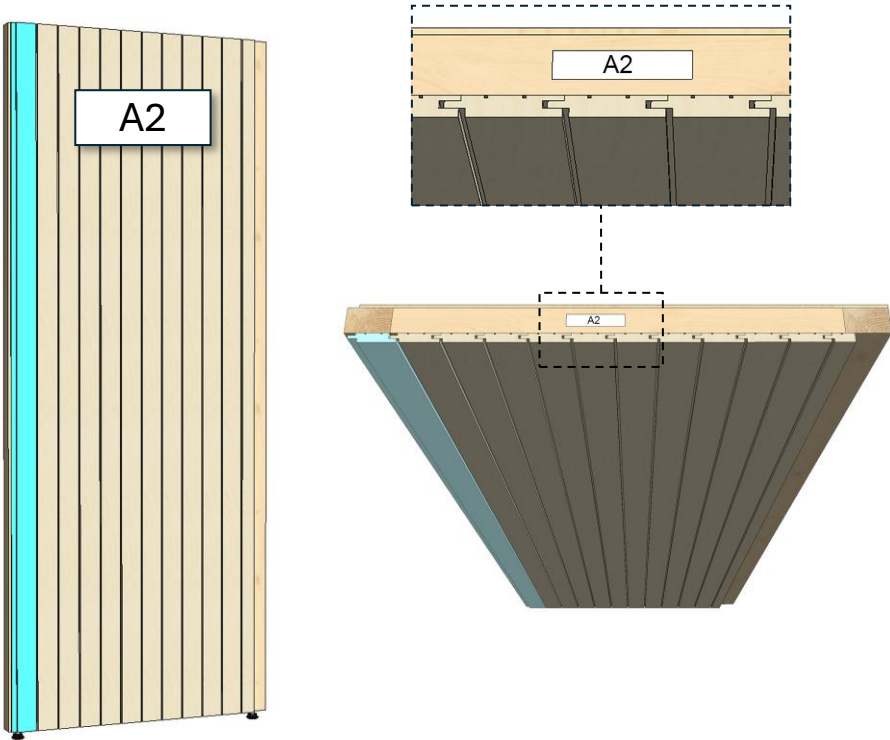

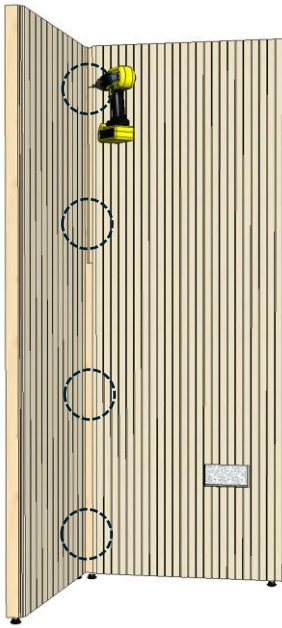
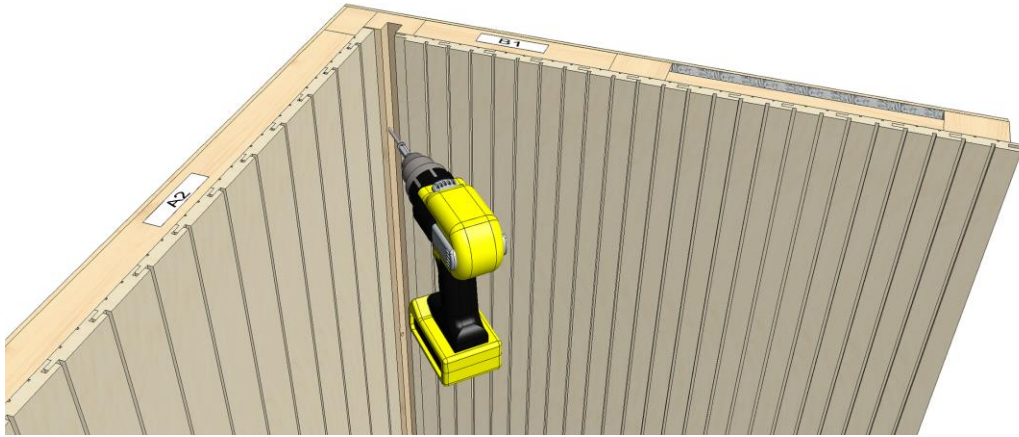

4 pcs Zn 5 * 50 mm

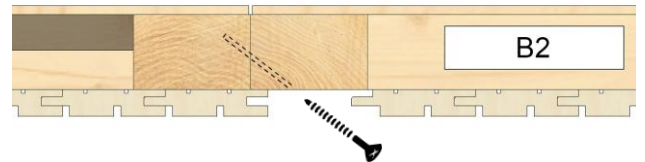
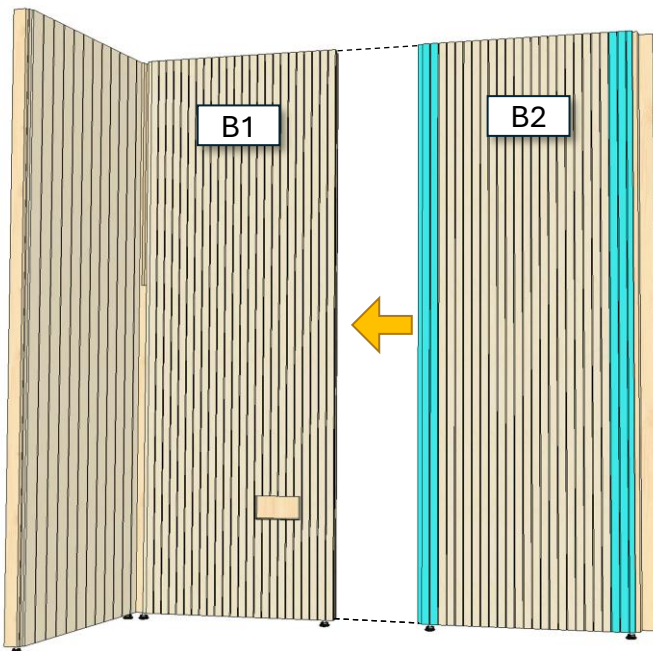

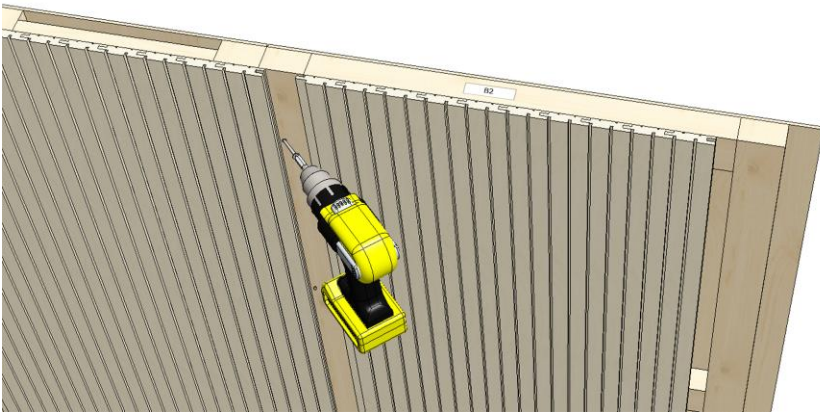

4 pcs Zn 5 * 50 mm

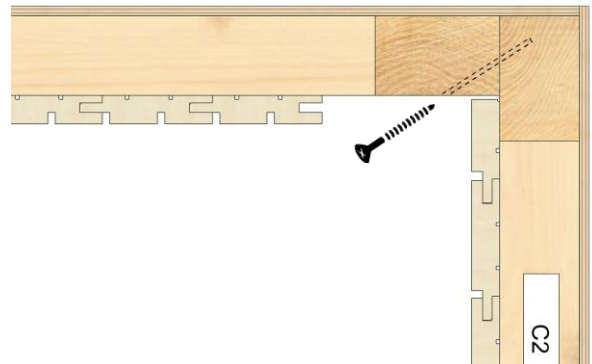
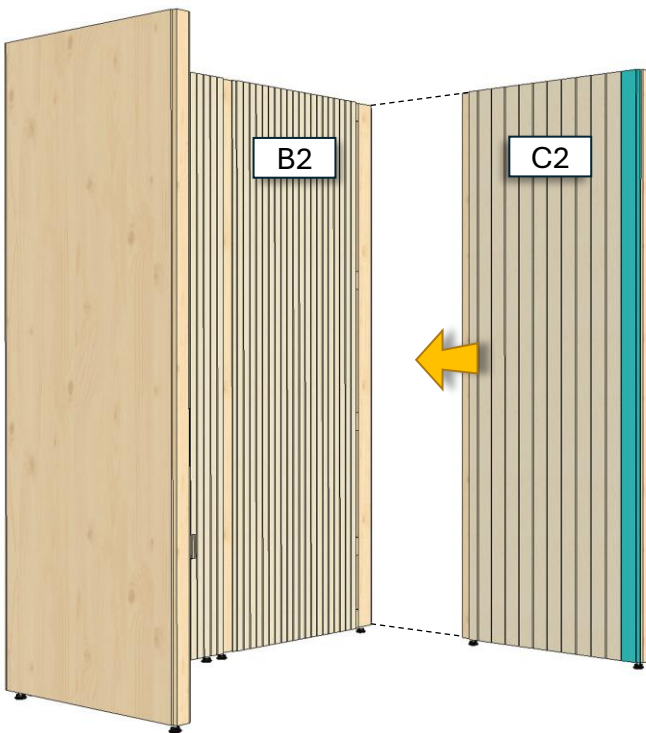
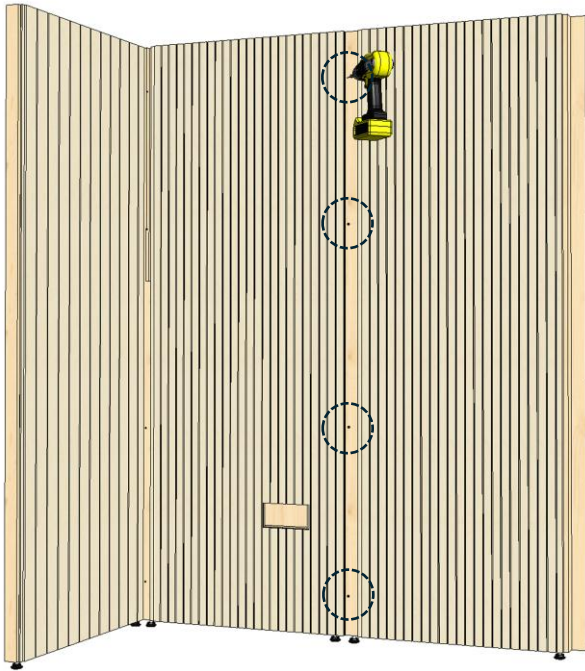

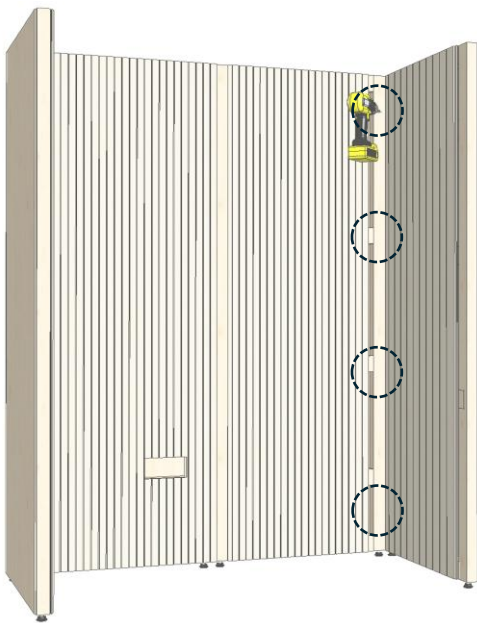
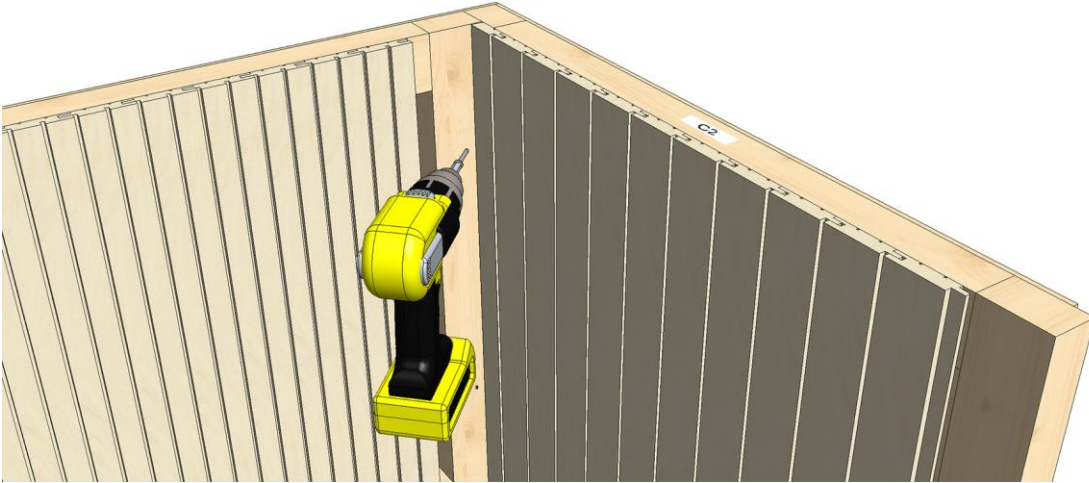

4 pcs Zn 5 * 50 mm



Right handed sauna

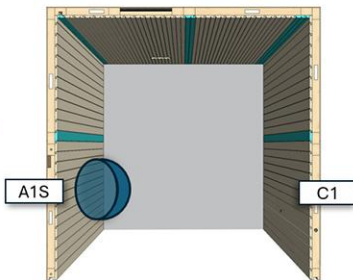
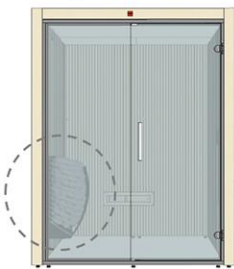

Left handed sauna

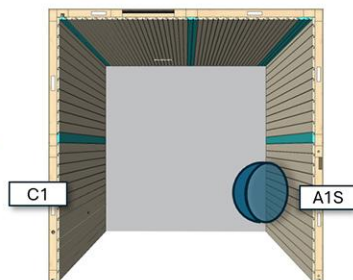
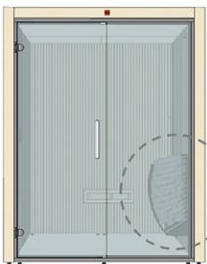

A1S	C1
-----	----

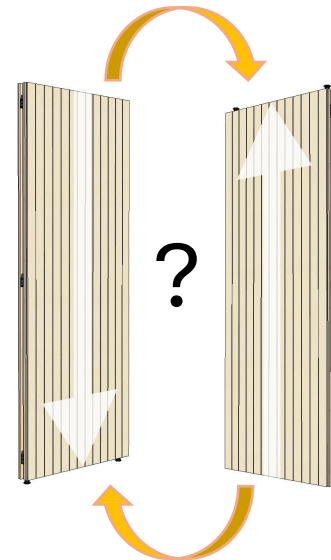

A1S C1

UPSIDE DOWN
NMOD
UPSIDE DOWN

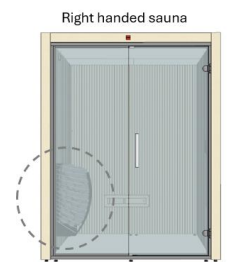
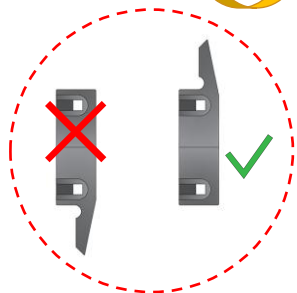
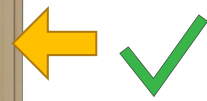
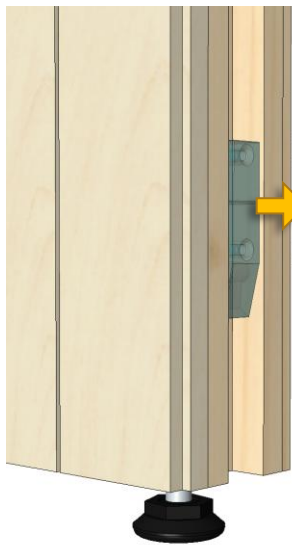
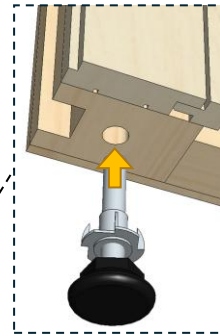
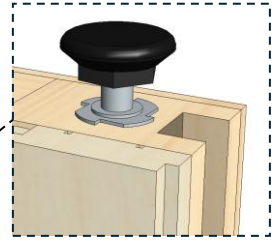
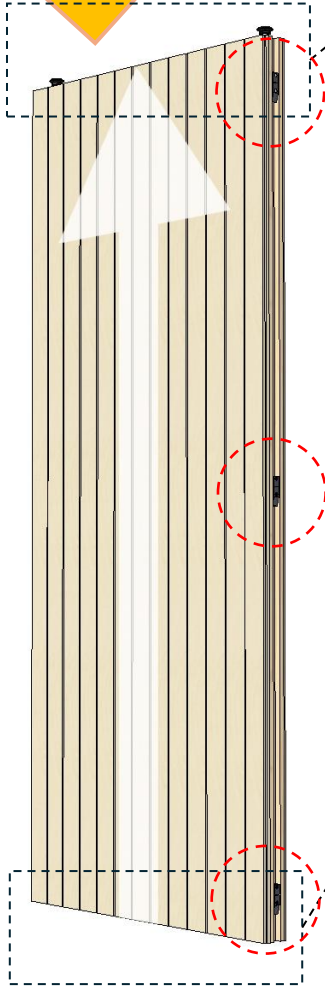
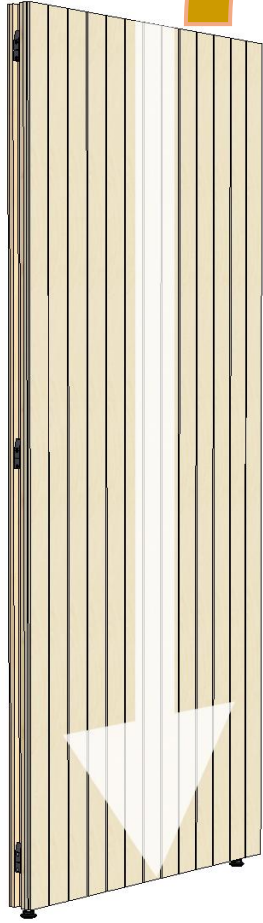

NOTE! Instructions continue from here on with the installation of a right-handed sauna. →

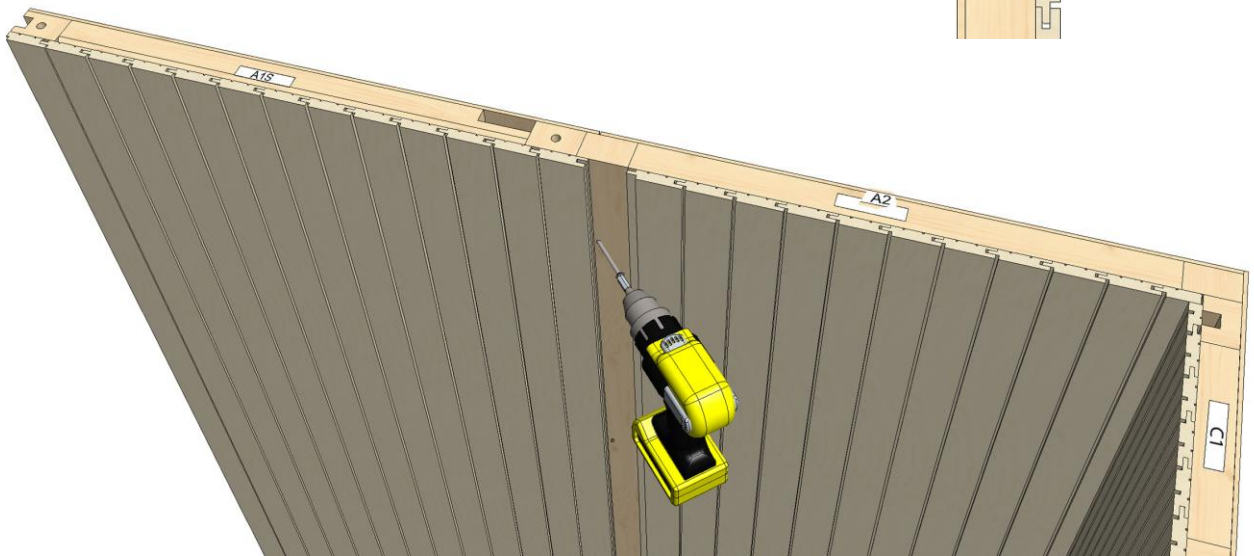
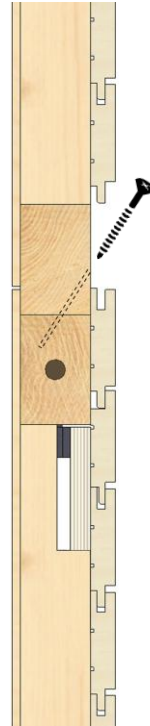
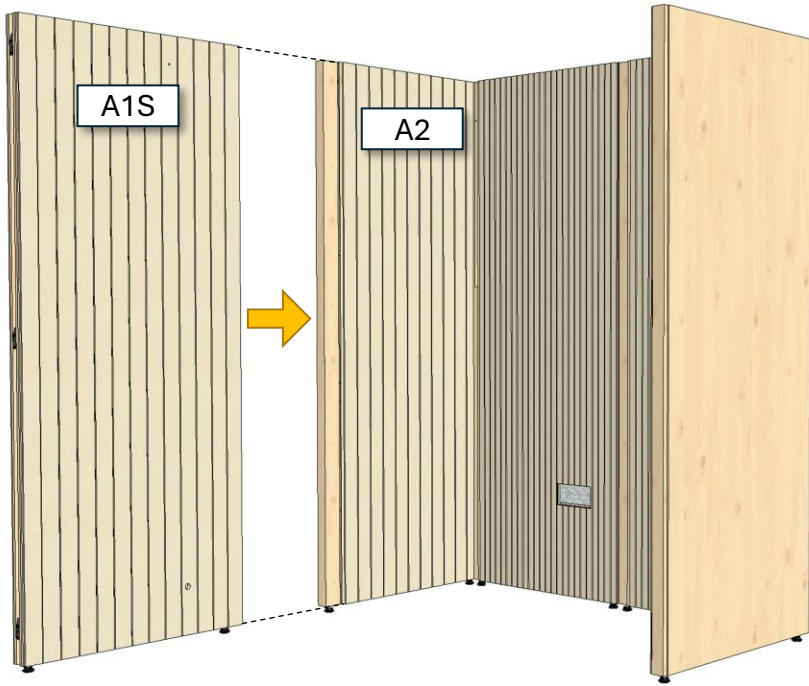

4 pcs Zn 5 * 50 mm

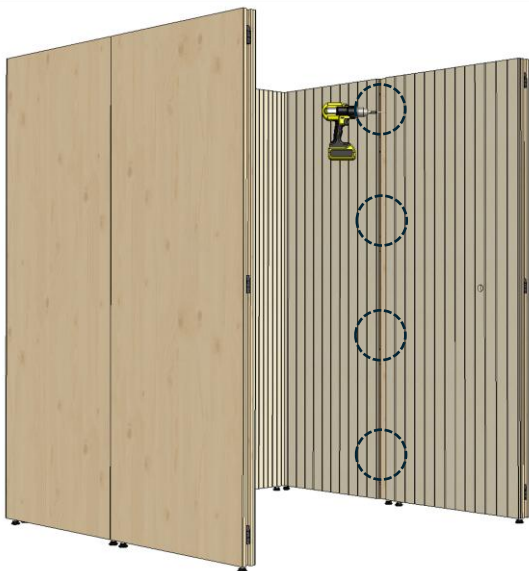
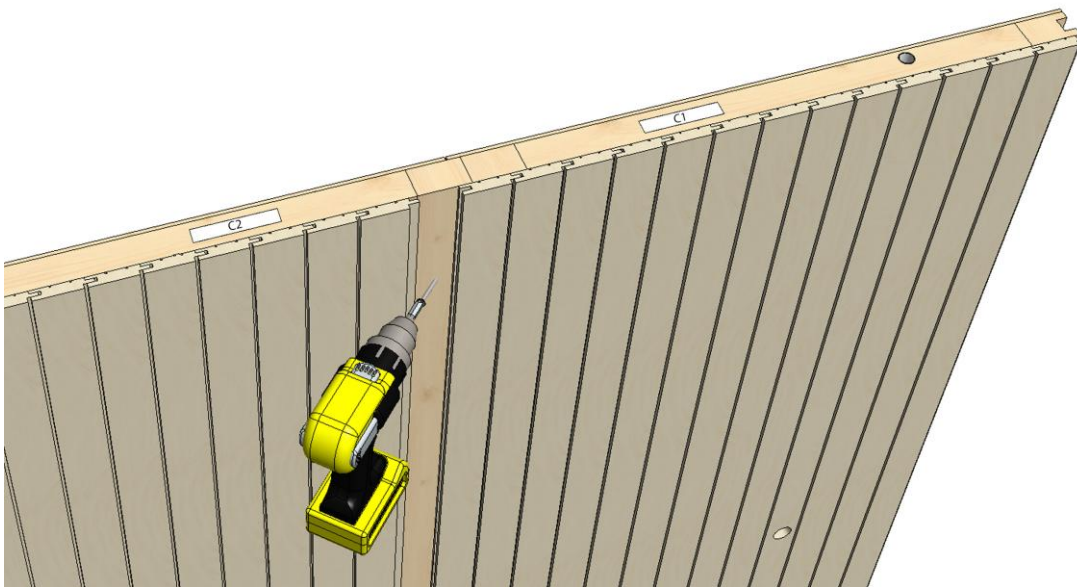
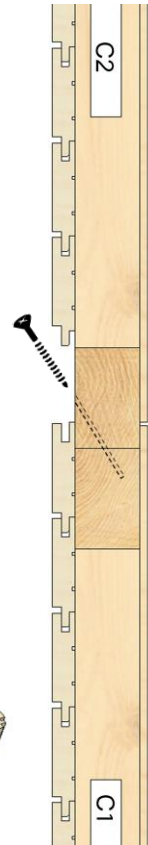

4 pcs Zn 5 * 50 mm





LOOSE PANELS

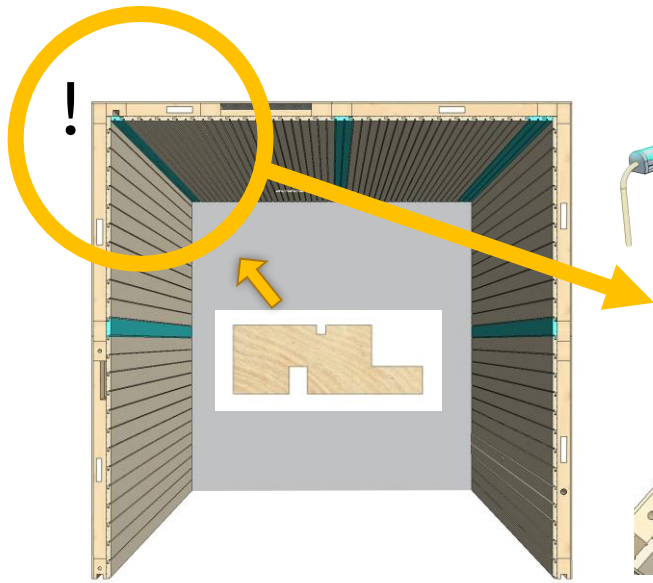

RGBW LED

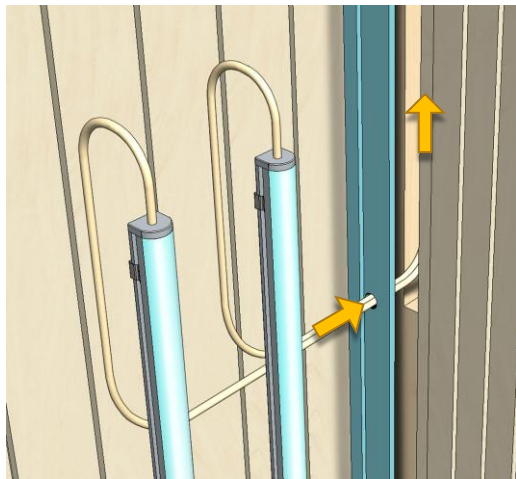
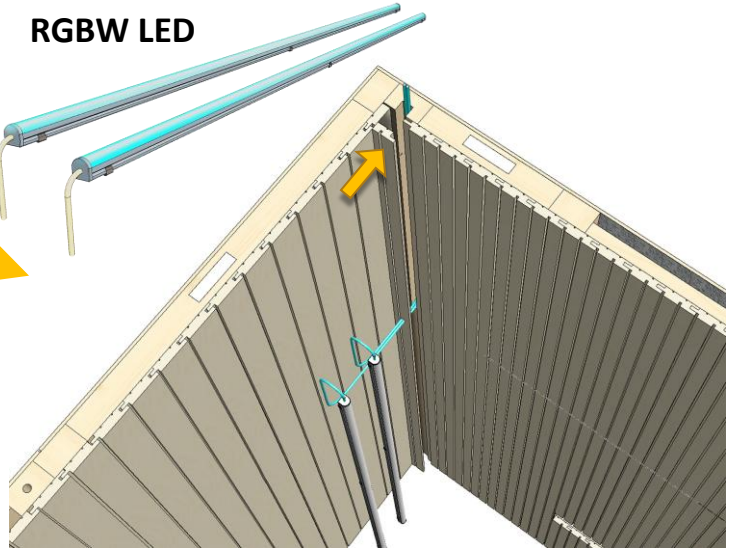

4 pcs Zn 1,7 * 45 mm

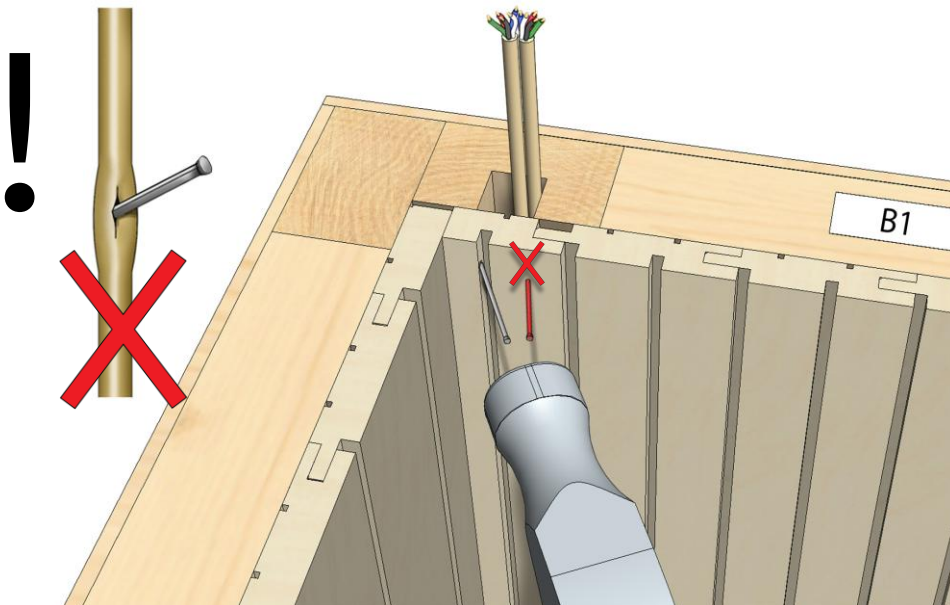
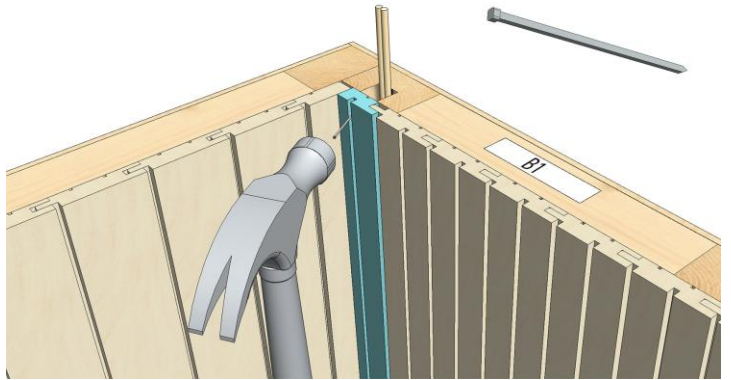

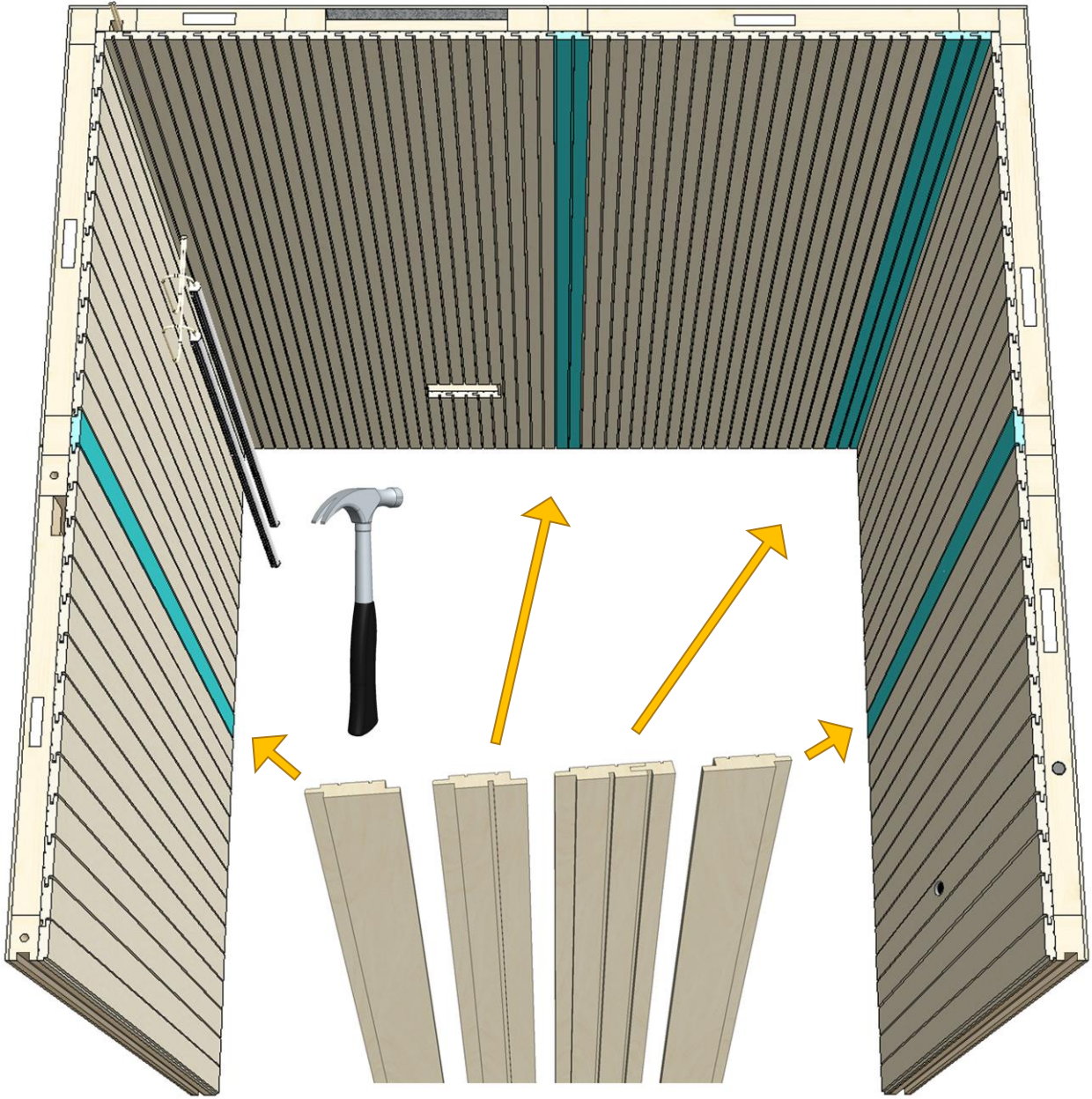

4 pcs Zn 1,7 * 45 mm

X 4



BACK REST

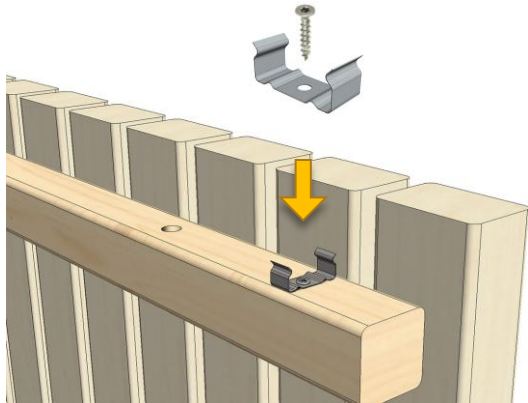
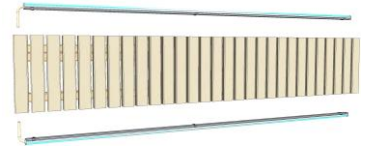

6 pcs Zn 3 * 25 mm

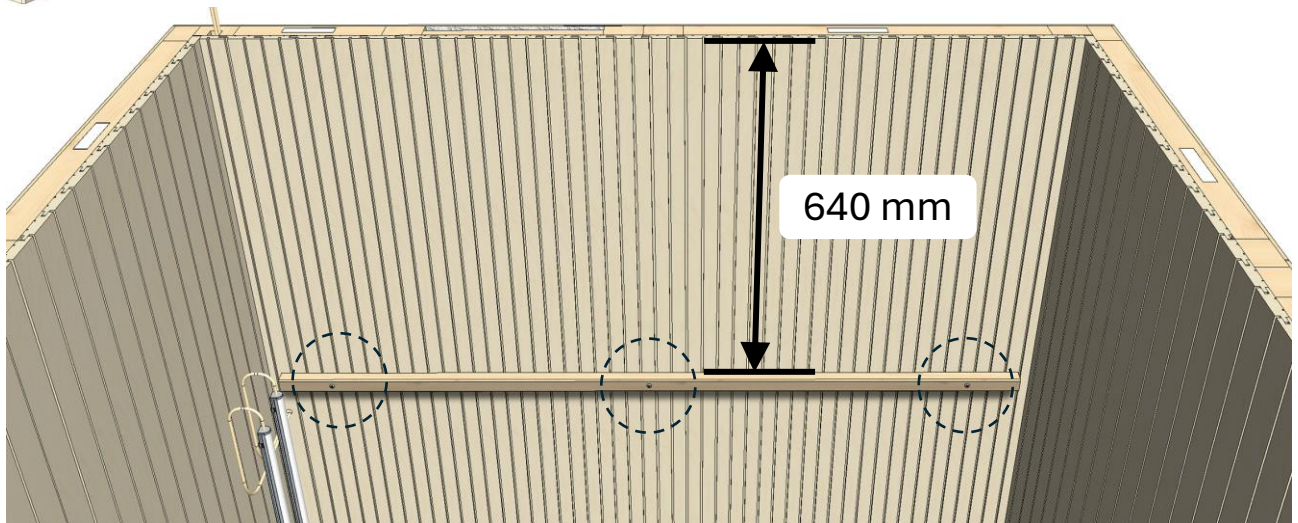
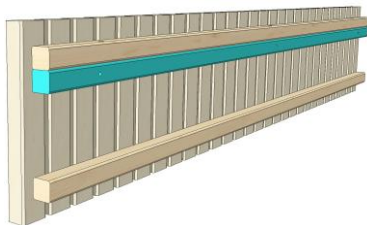
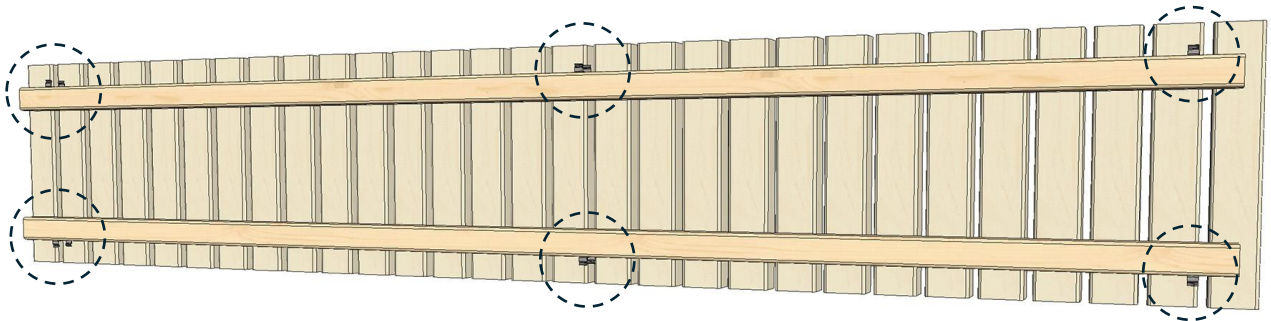

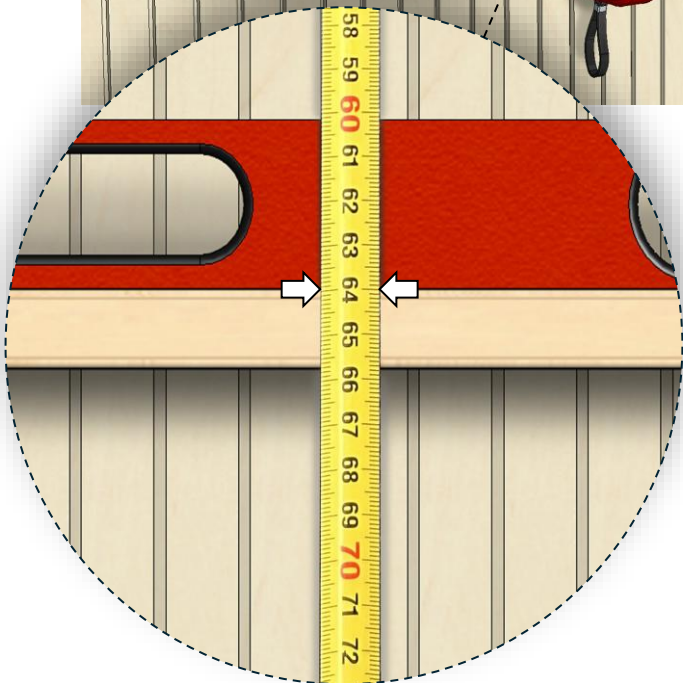
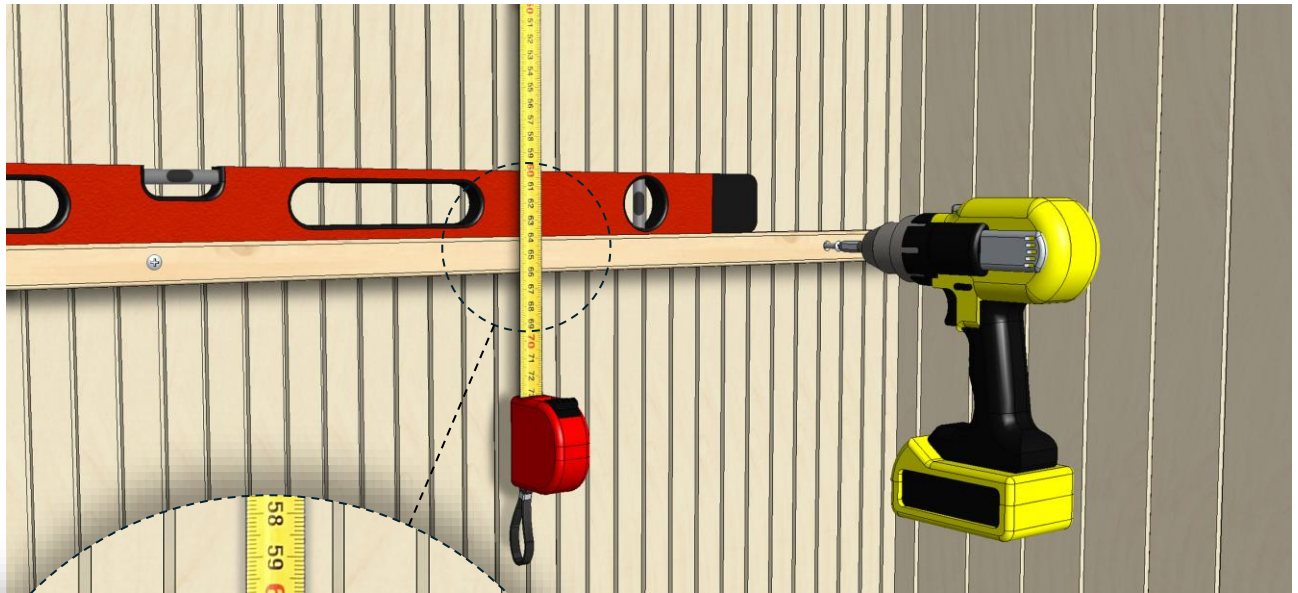

3 pcs Zn 4,5 * 50 mm

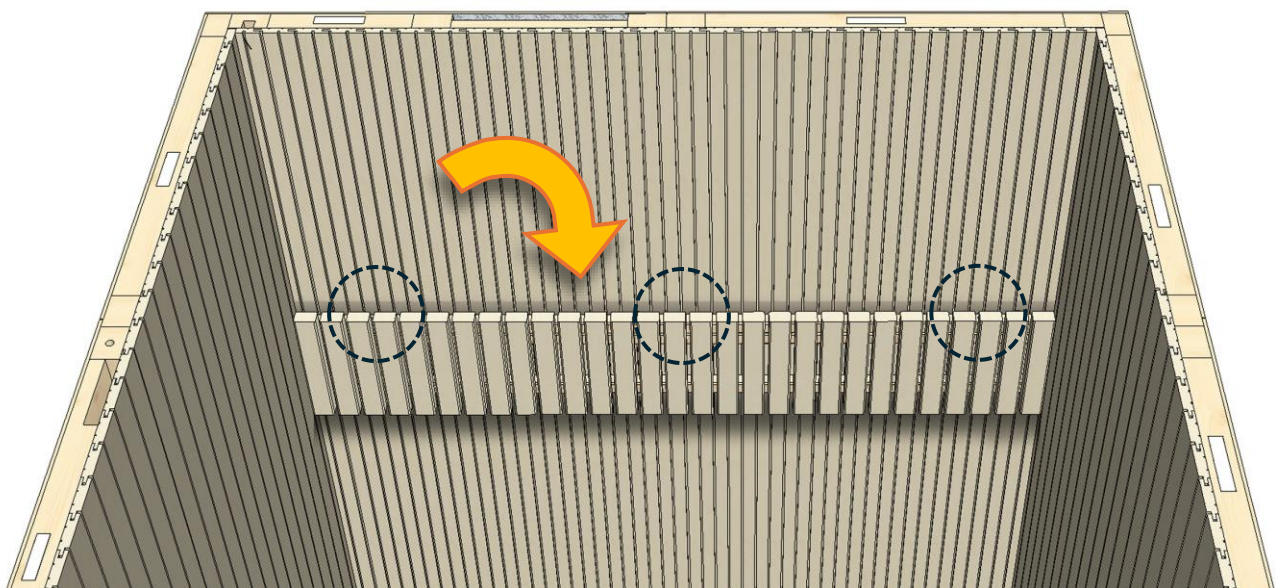
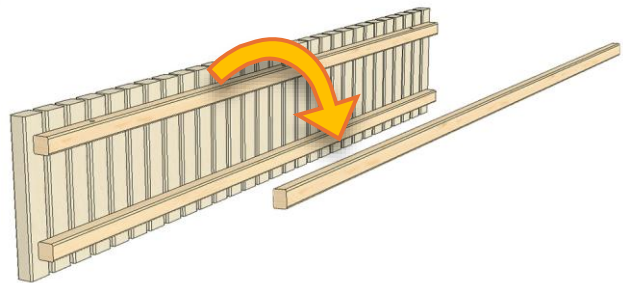

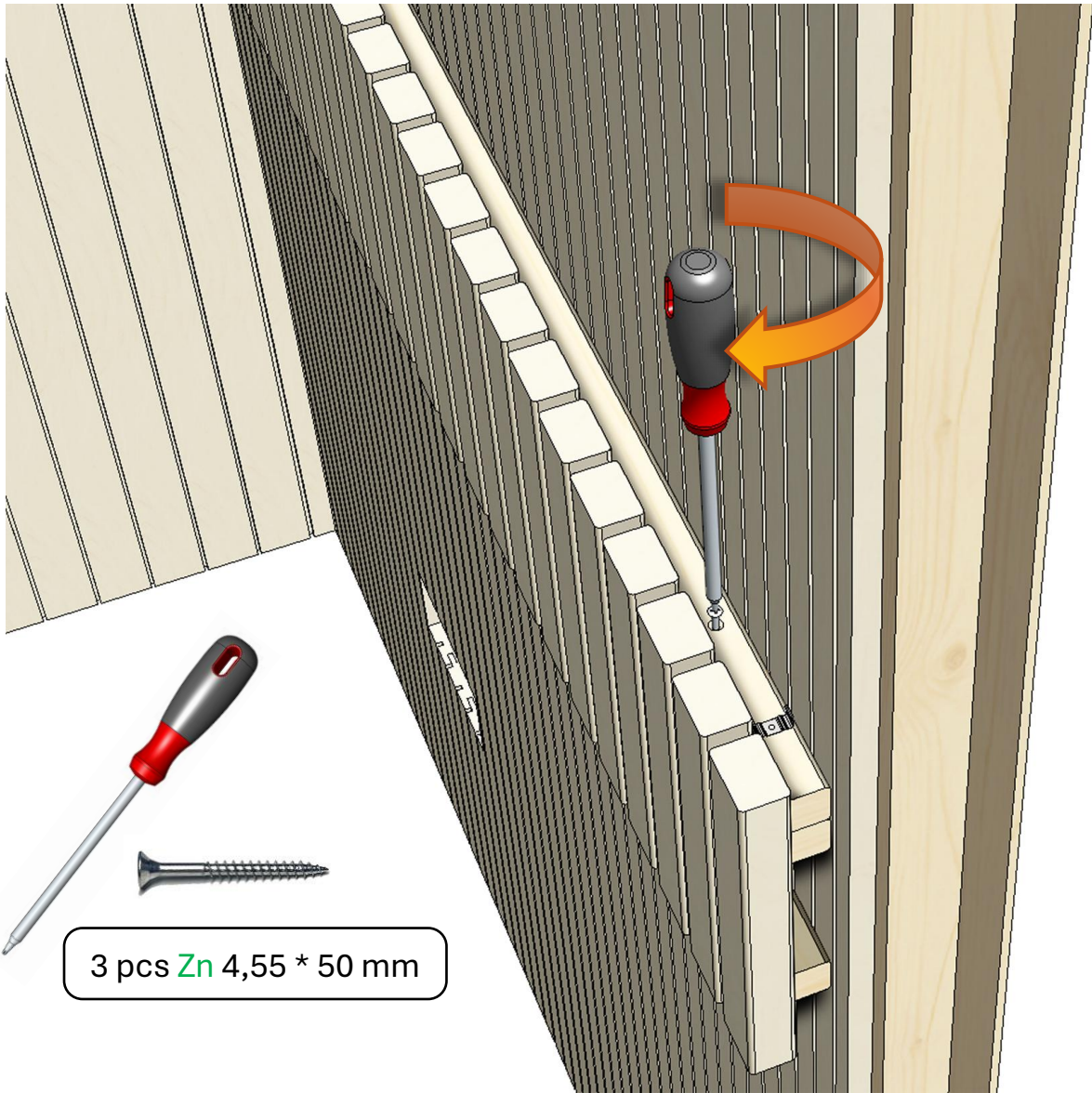

3 pcs Zn 4,55 * 50 mm

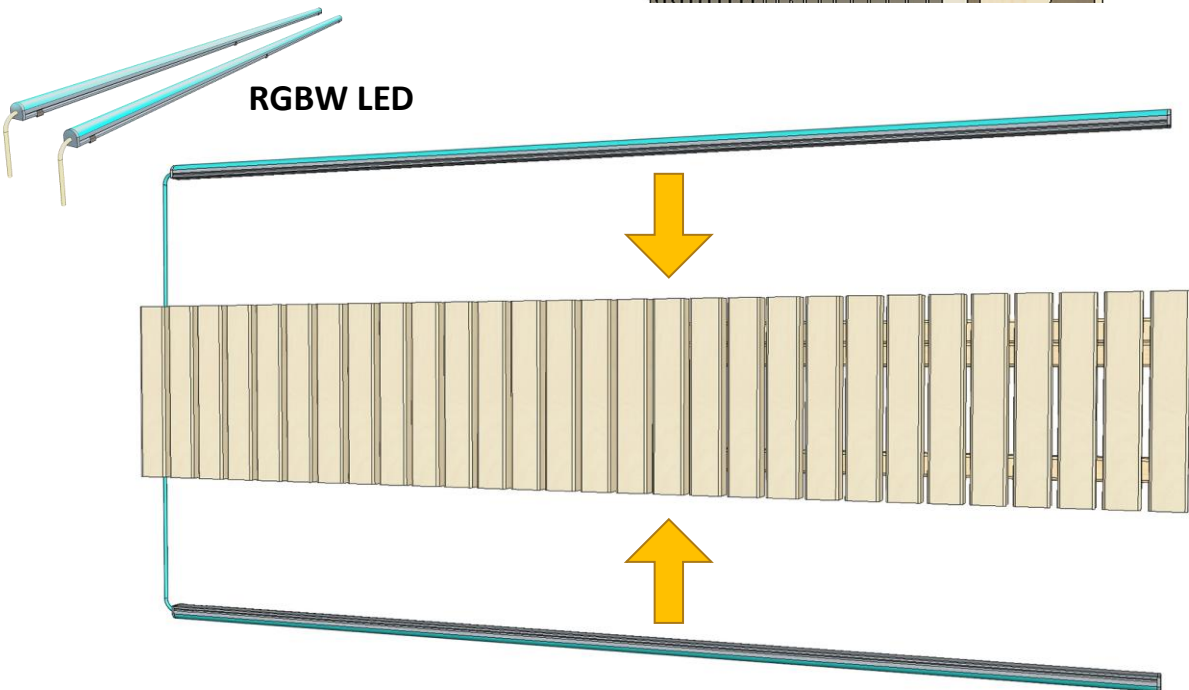

RGBW LED

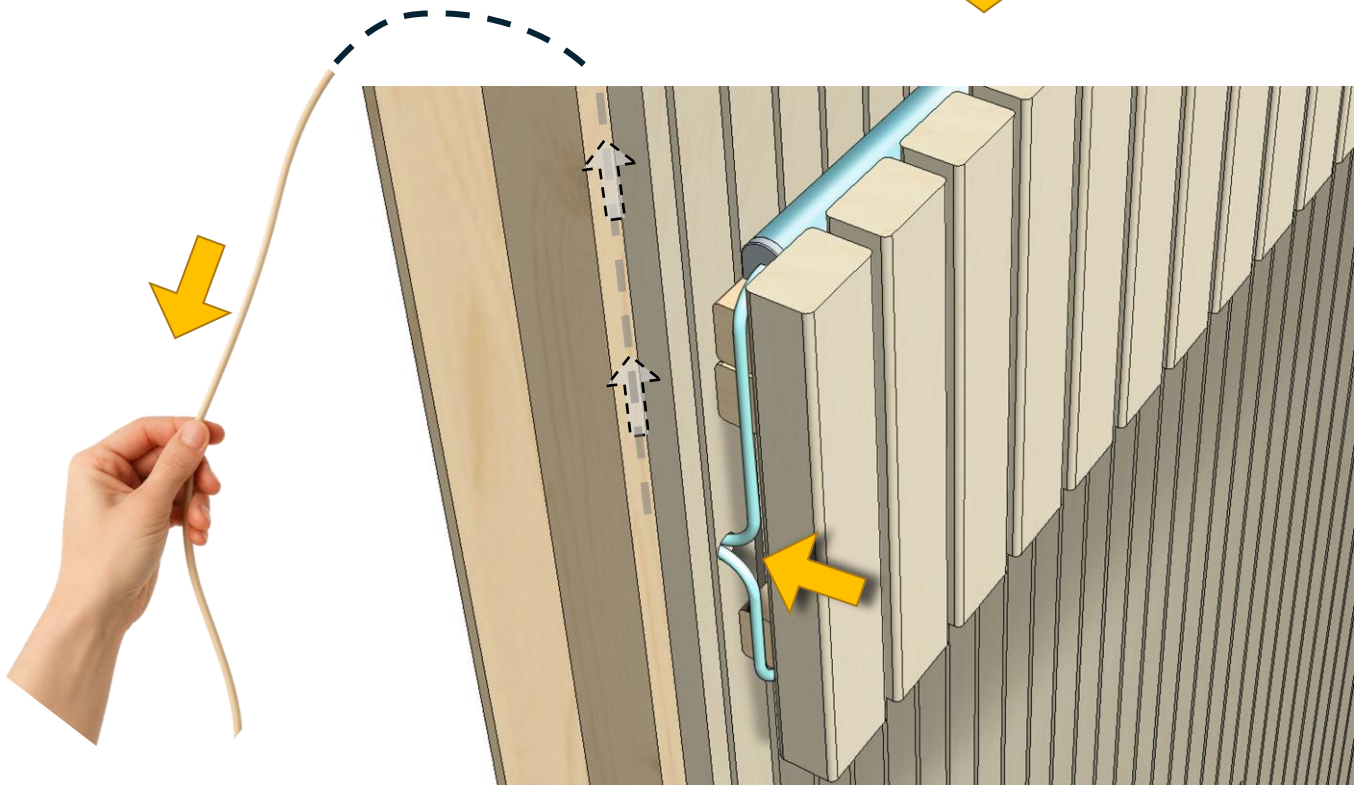
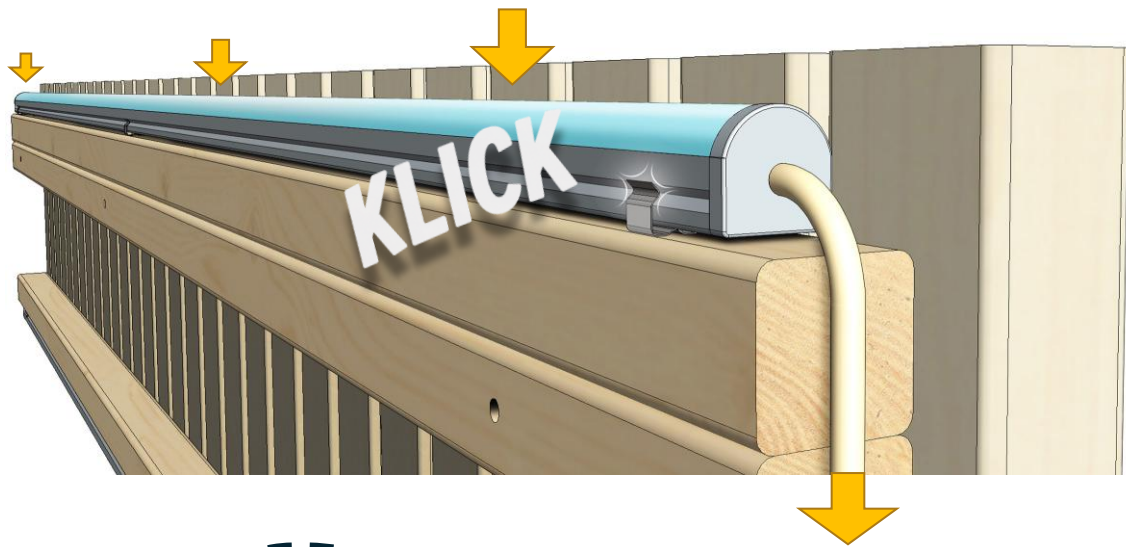

FRONT WALL FRAMES

Right handed sauna

(Left handed sauna -> p.21)

1

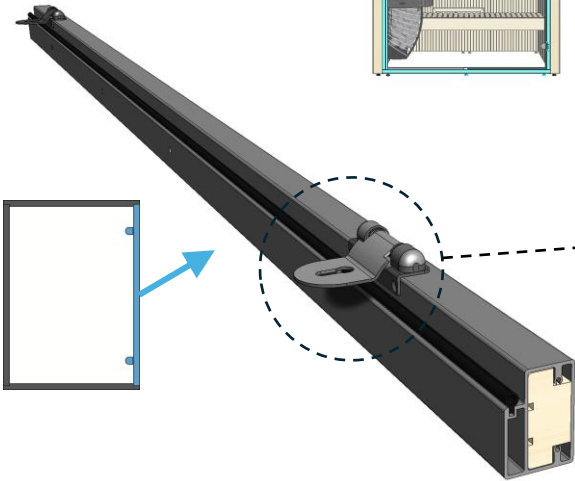

2

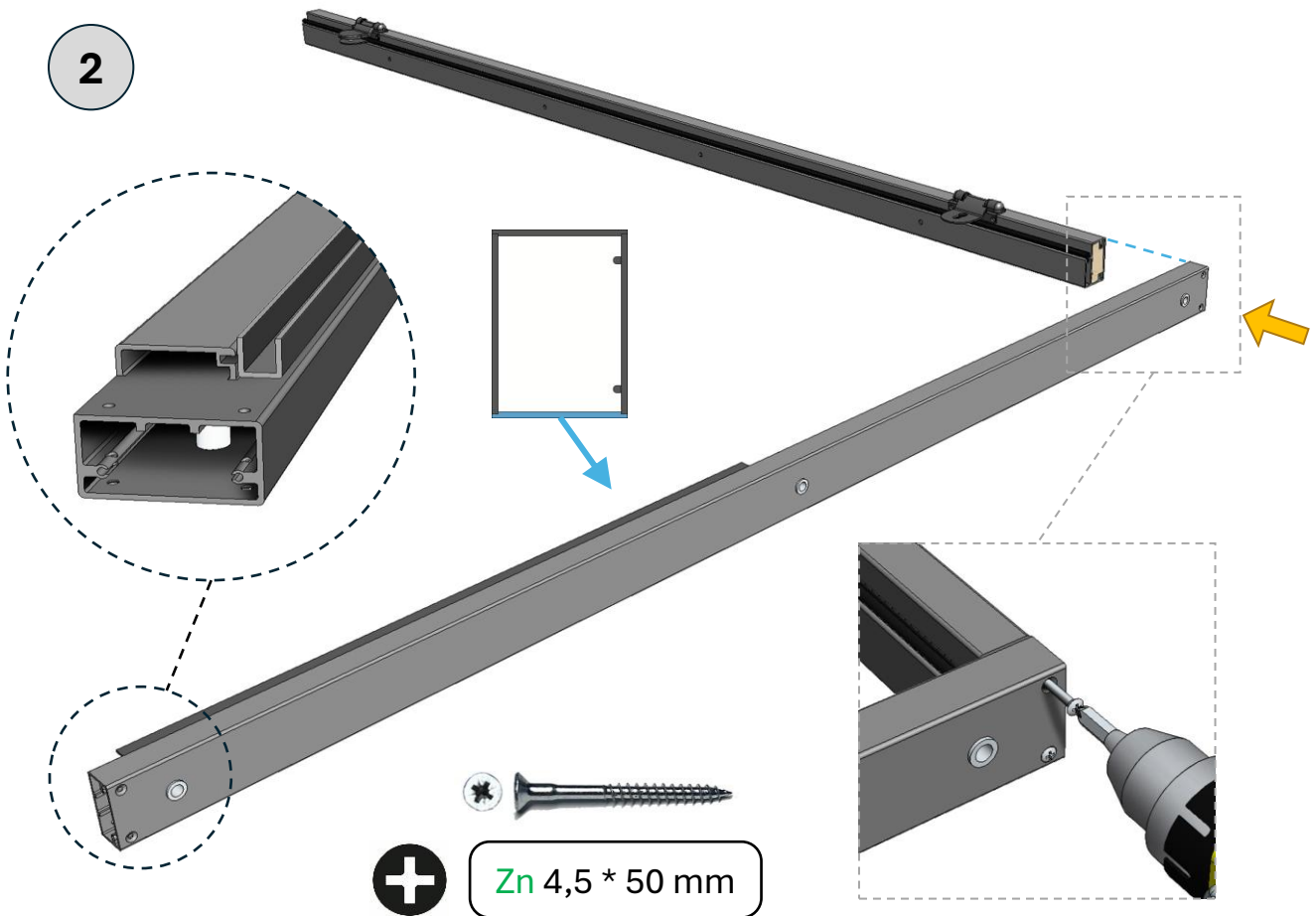

3

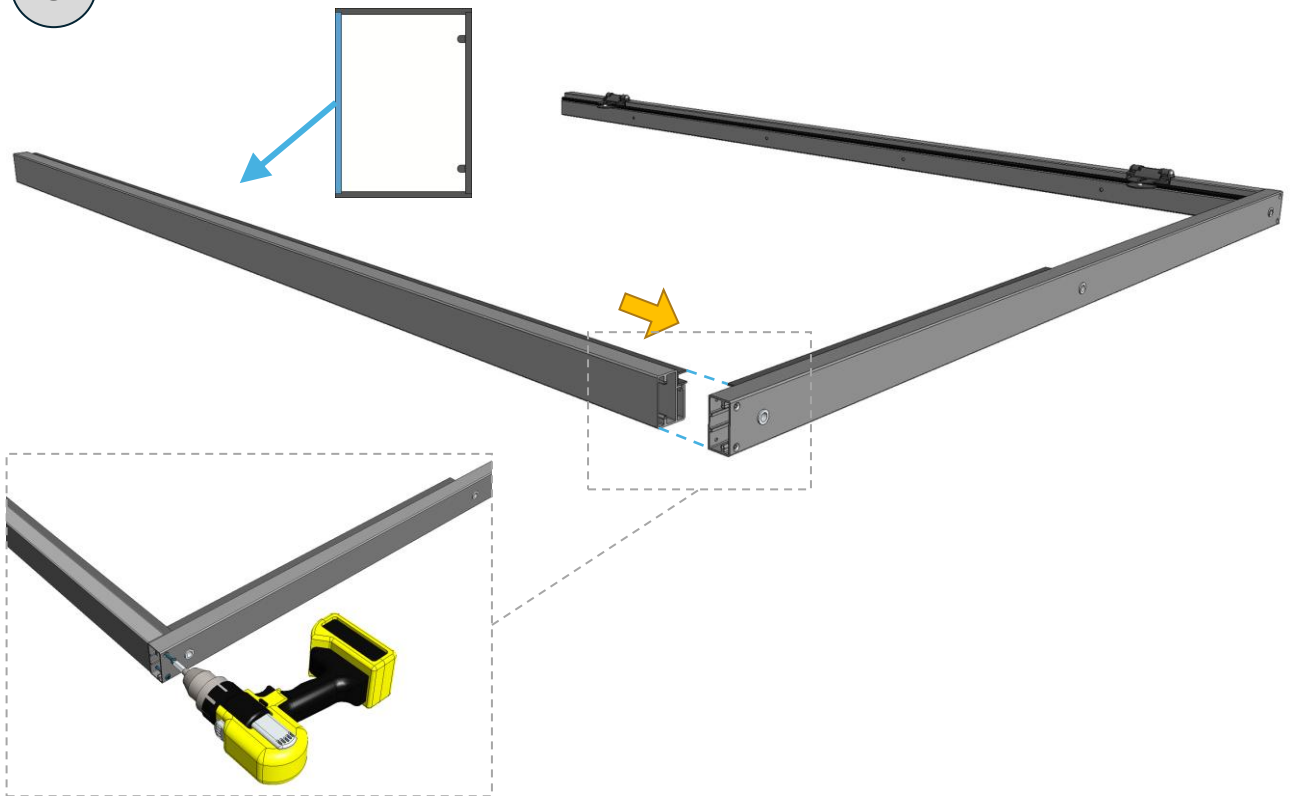

4

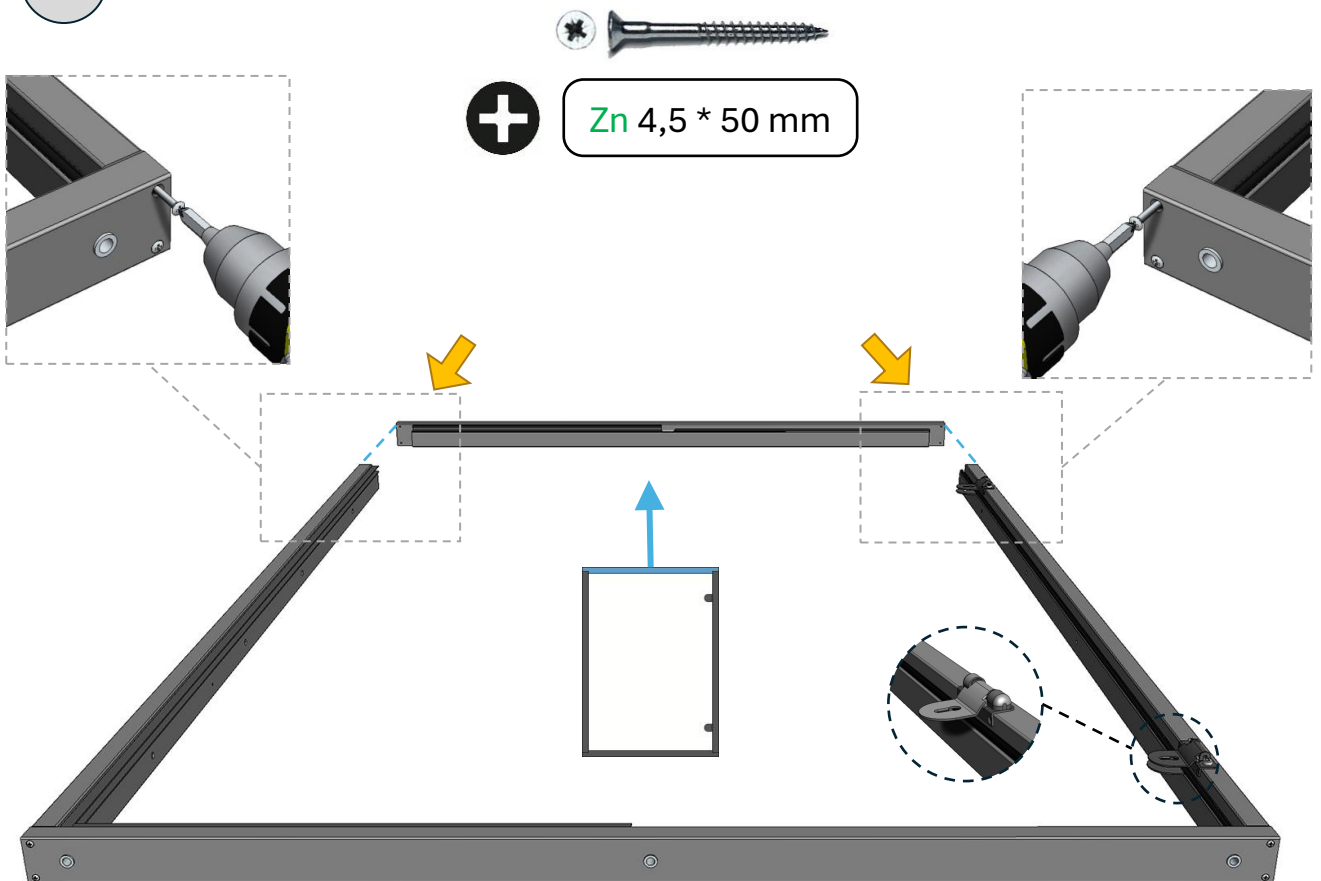

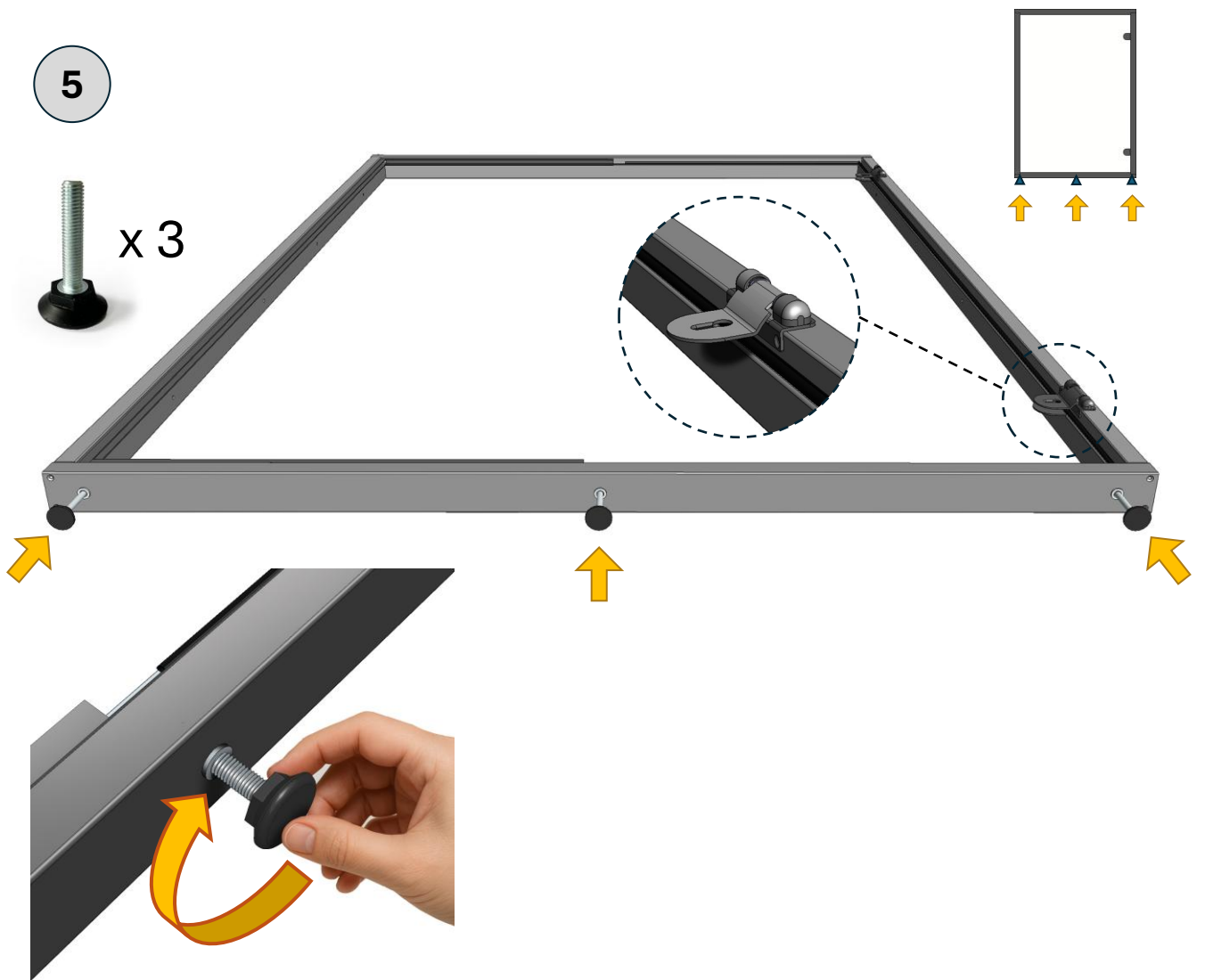

6

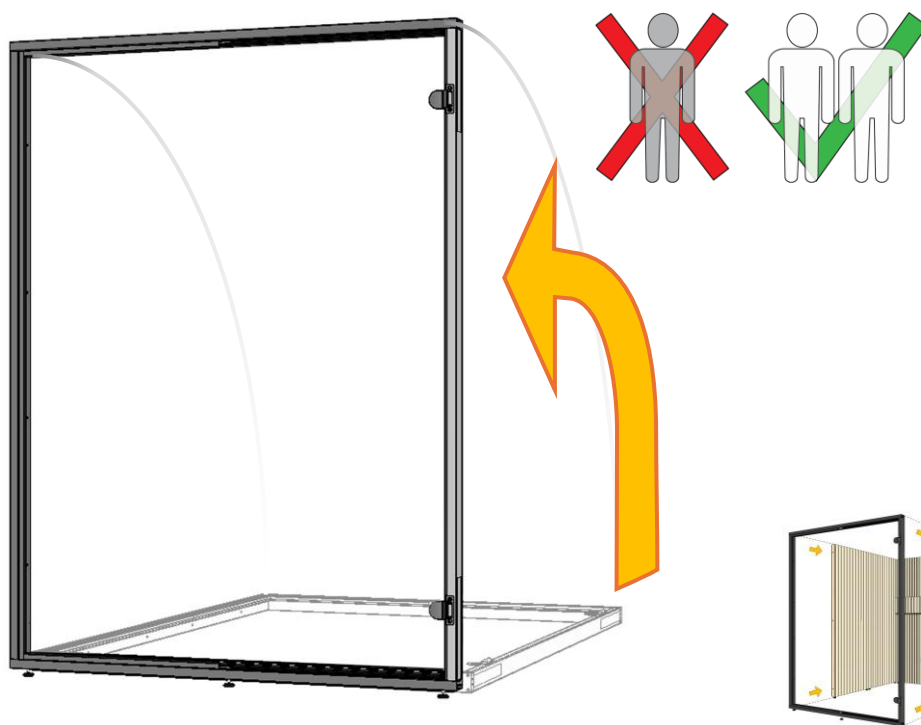

FRONT WALL FRAMES

Left handed sauna
(Right handed sauna -> p.20)

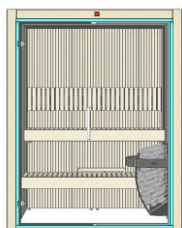

1

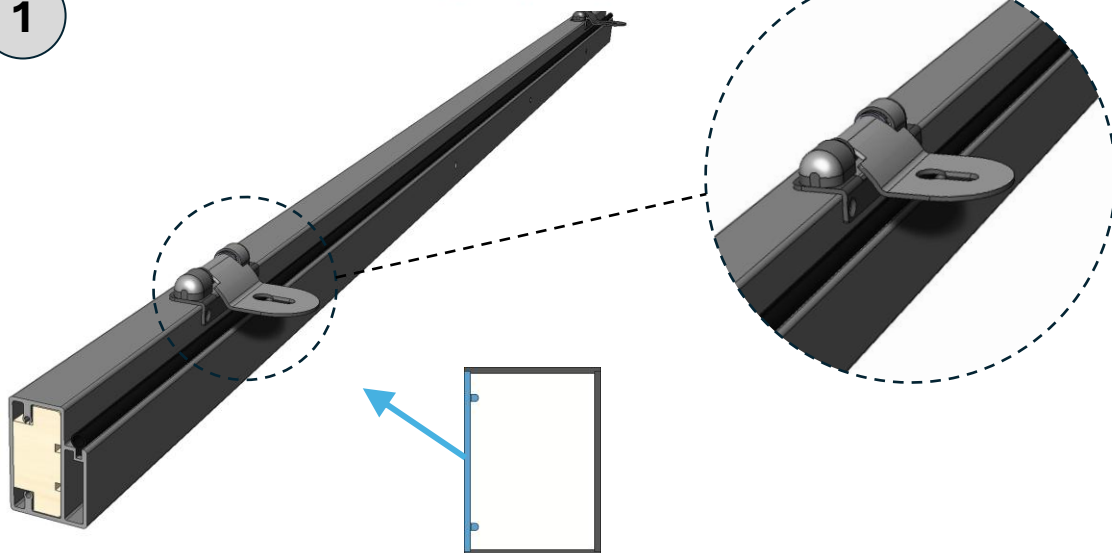

2

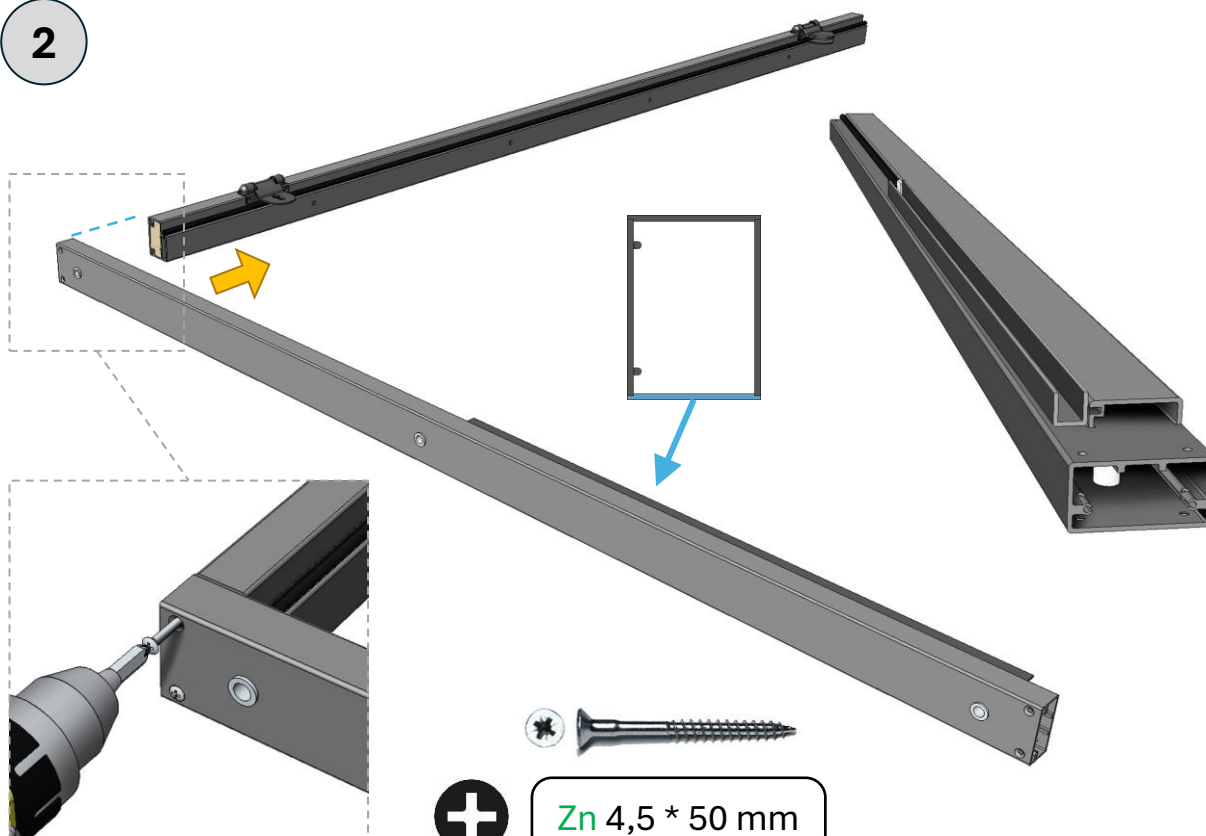

Zn 4,5 * 50 mm

3

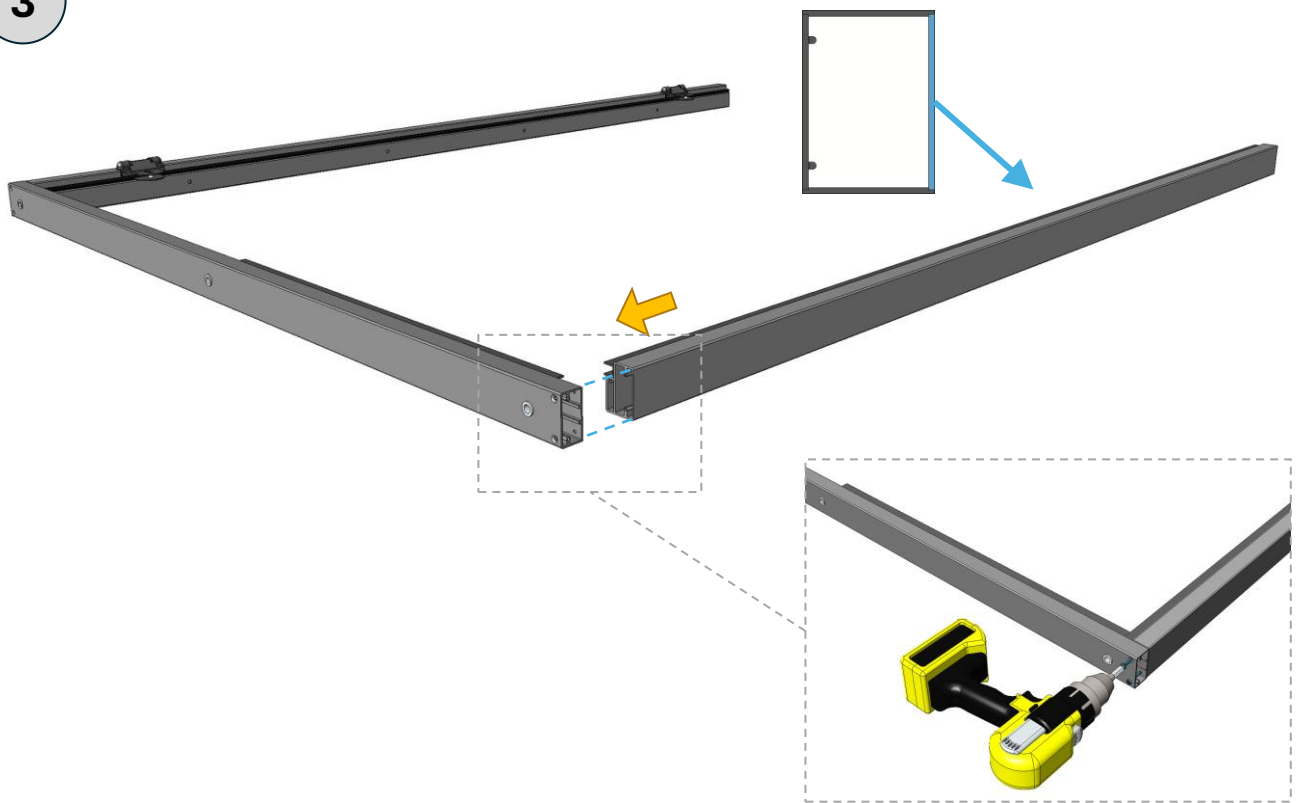

4

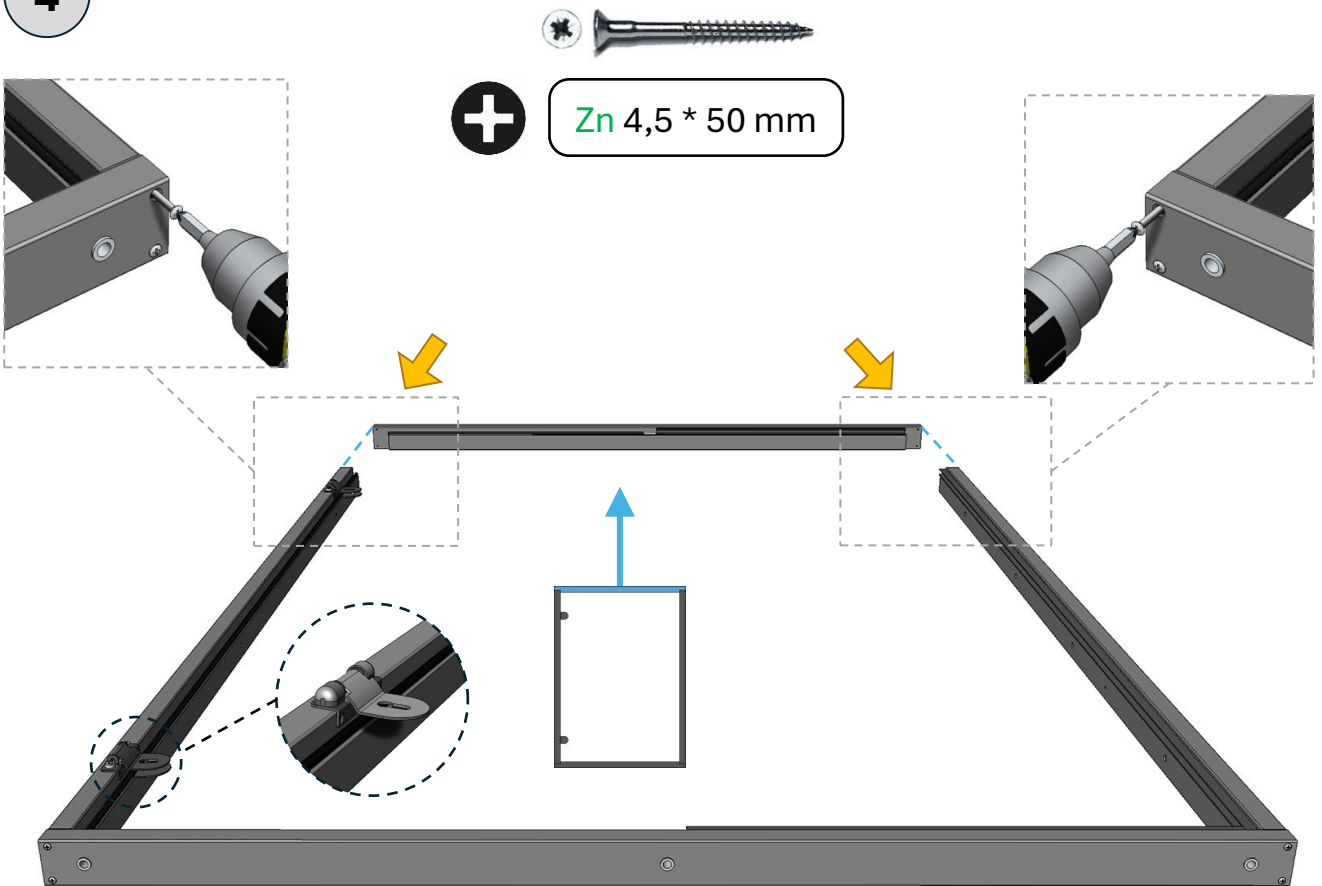

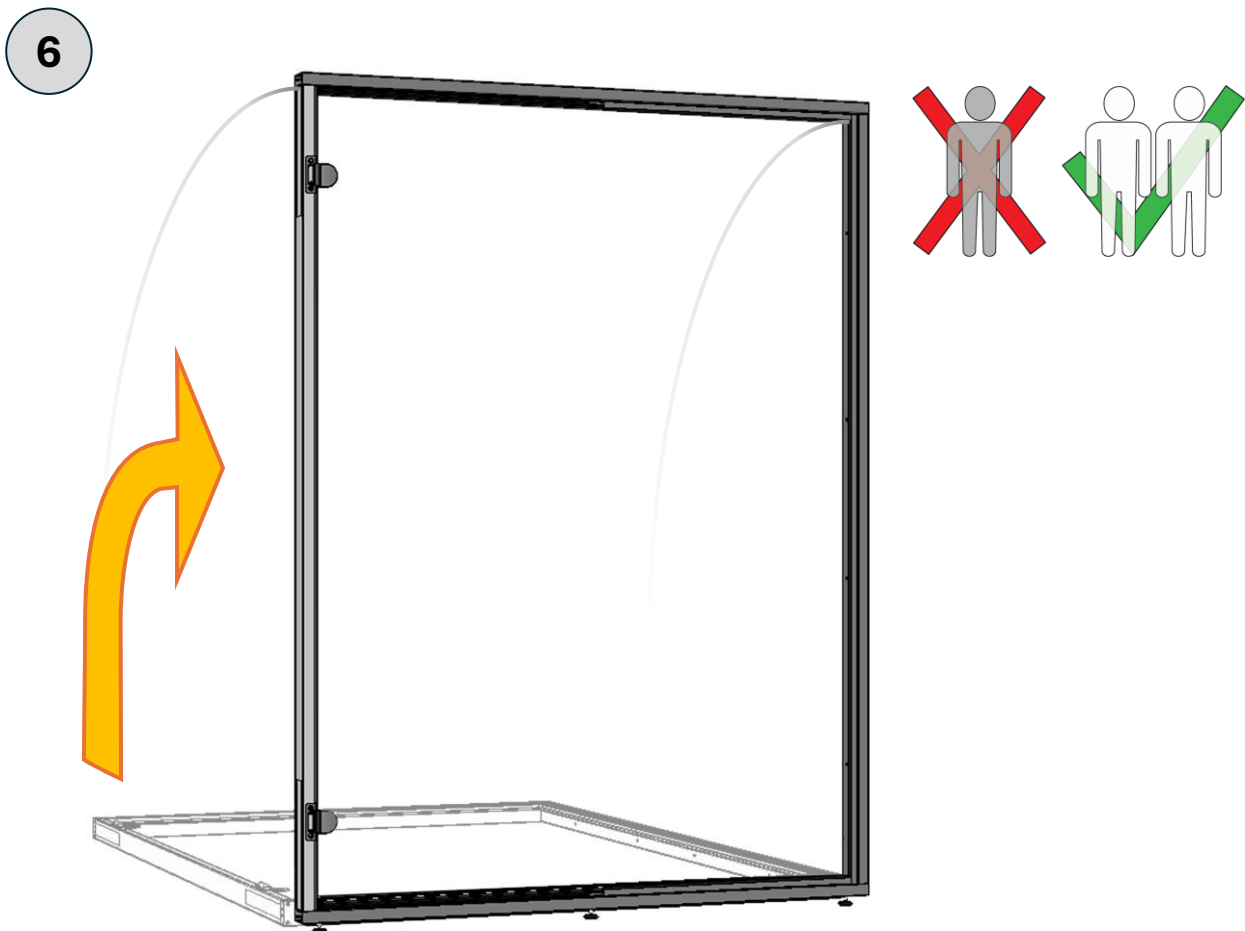
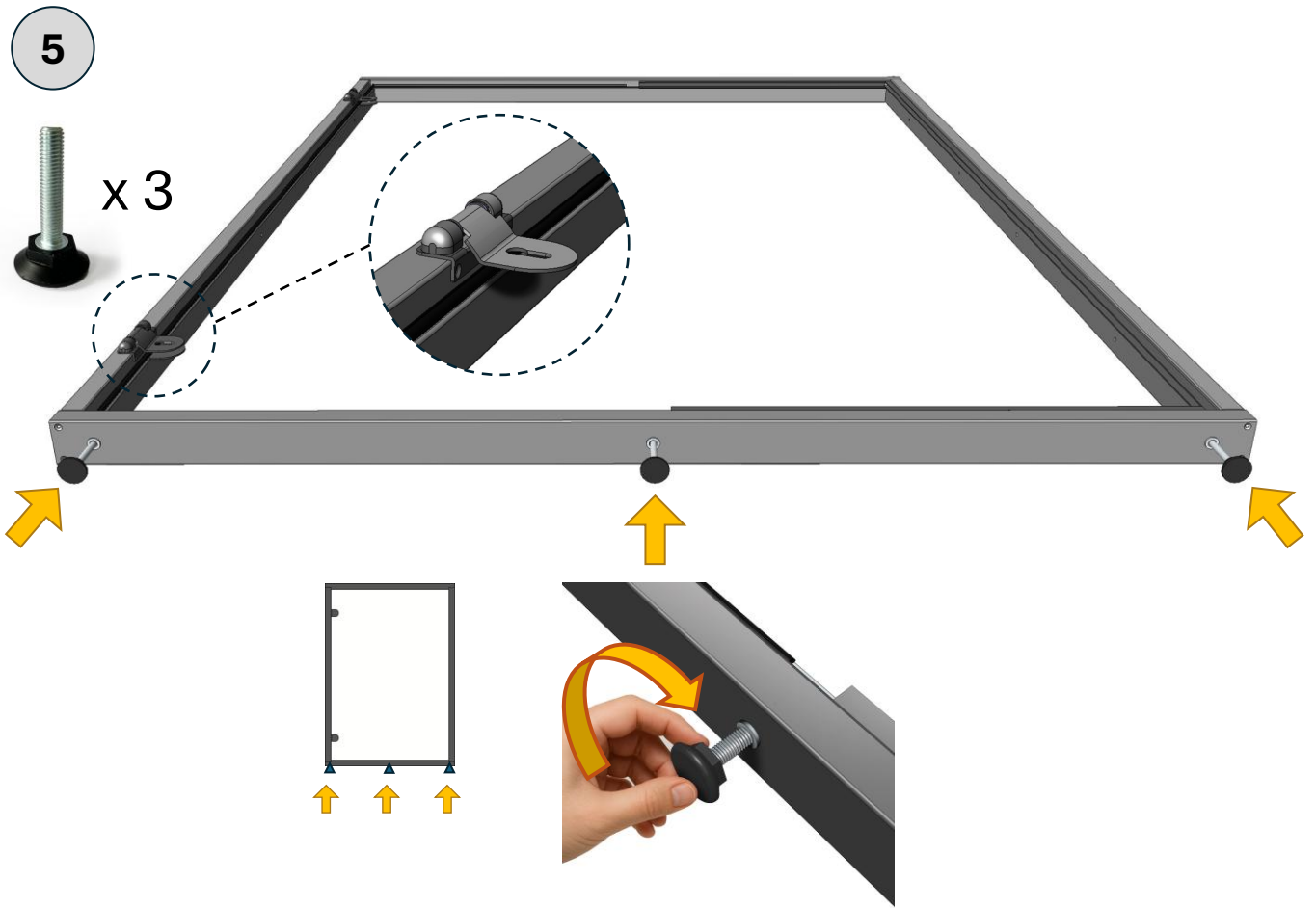

INSTALLATION OF FRAMES

Right handed sauna

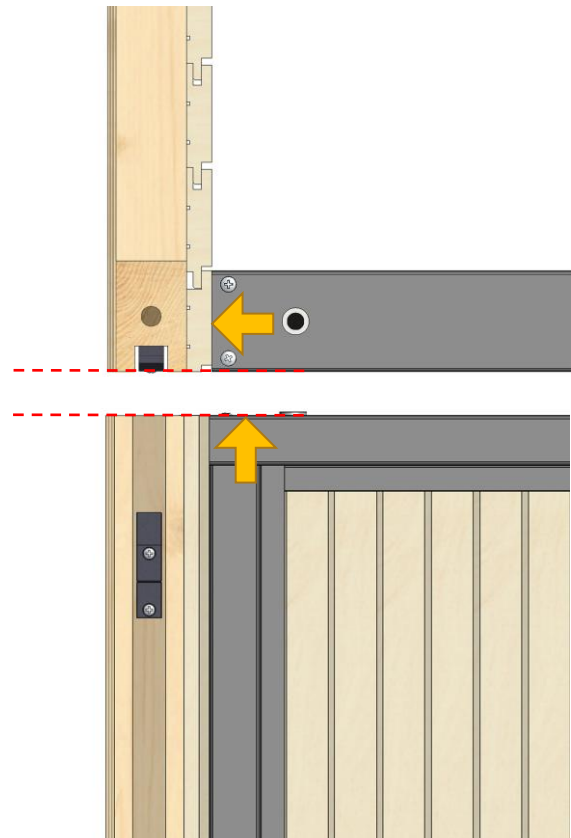
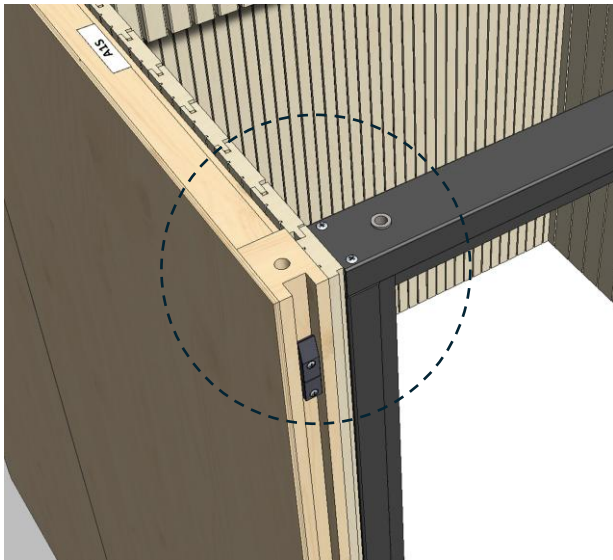

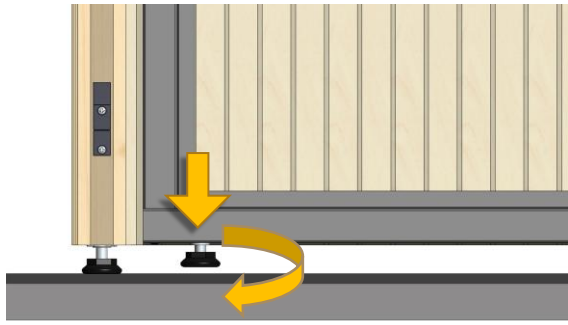

25 mm

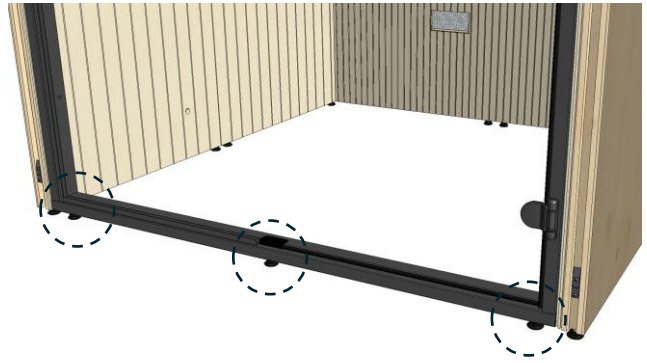

8 pcs Zn 4,5 * 50 mm

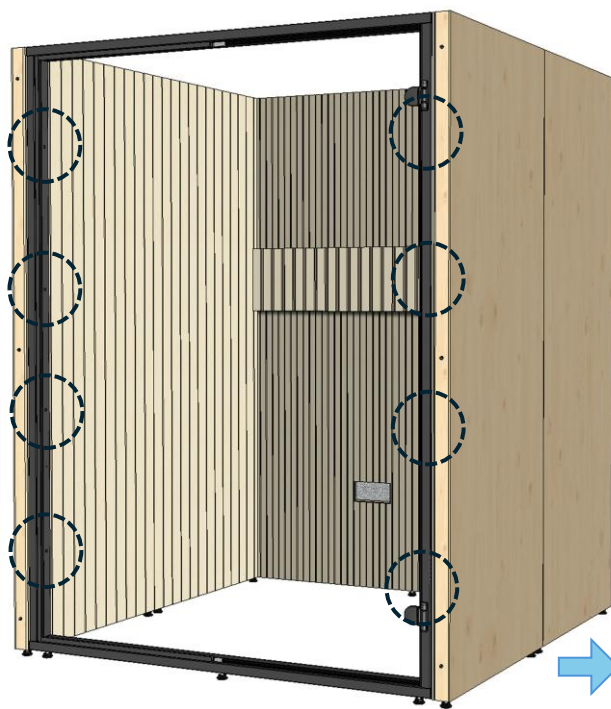





VERTICAL FASCIA BOARDS

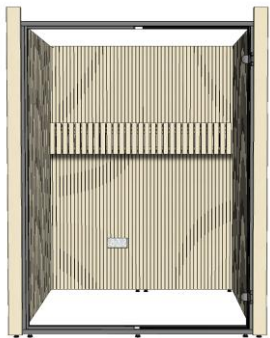
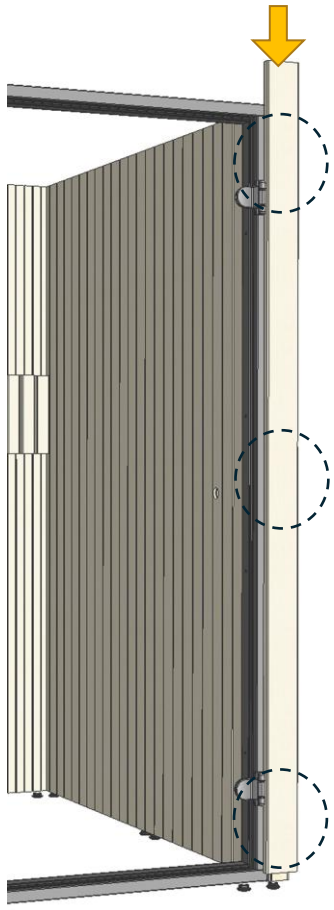
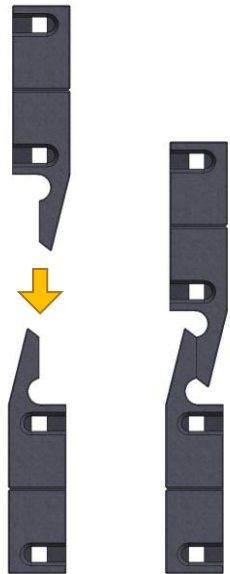
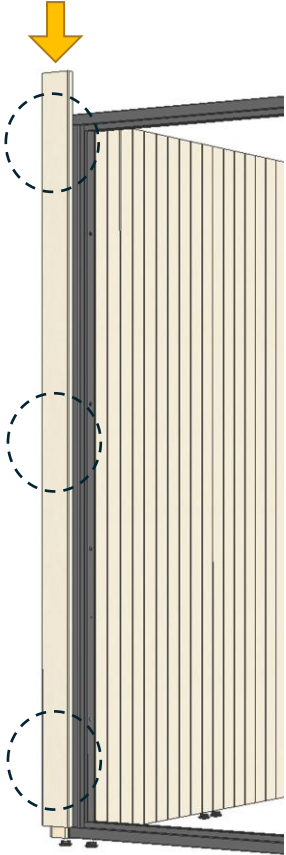
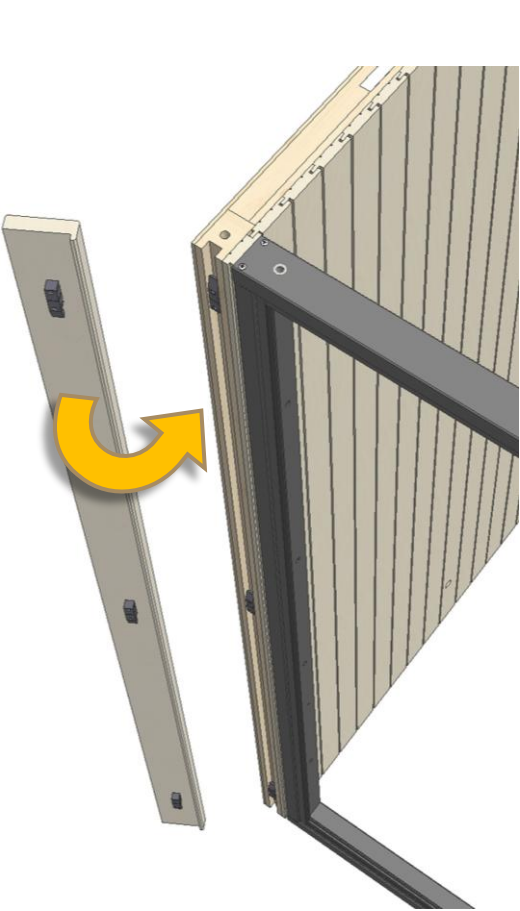



GASKET FOR ROOF

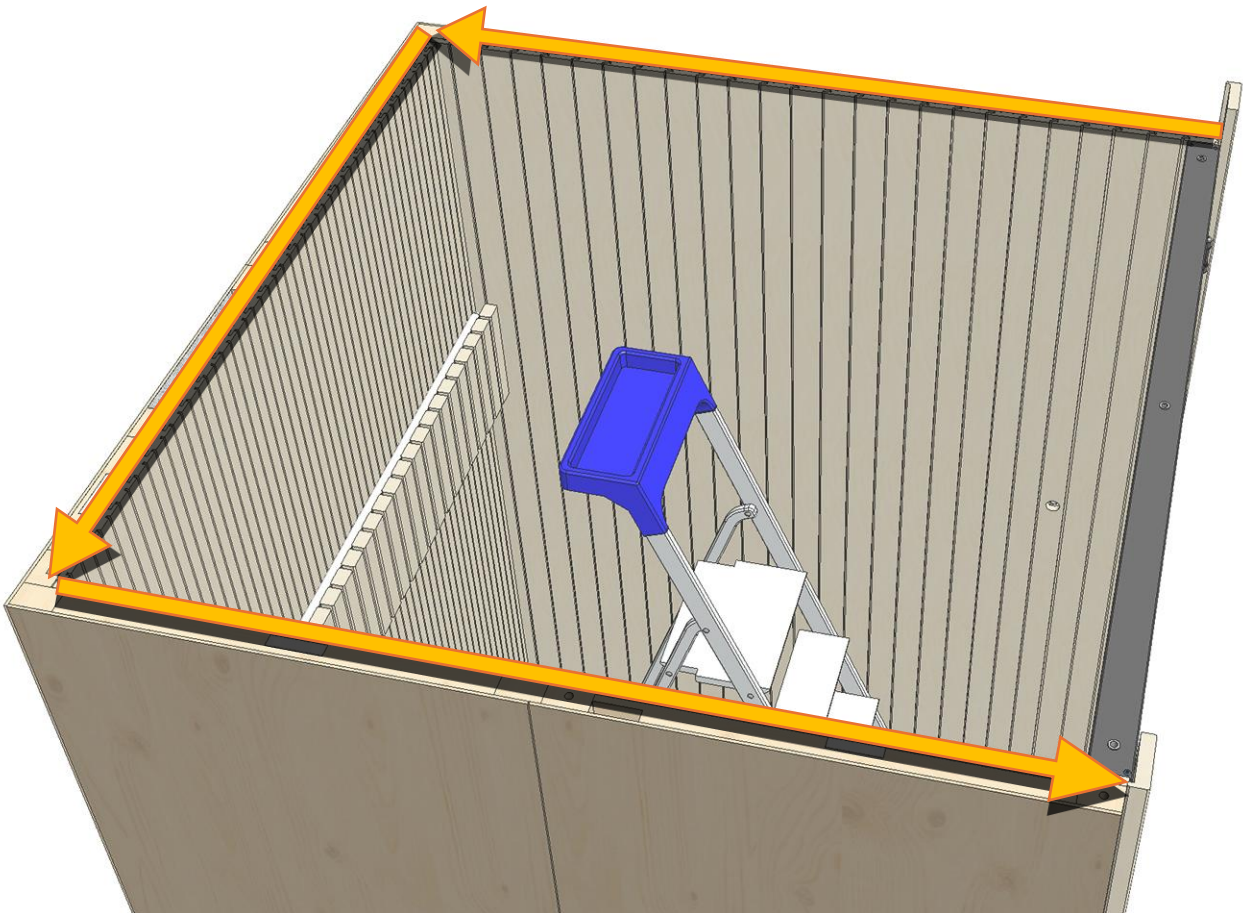
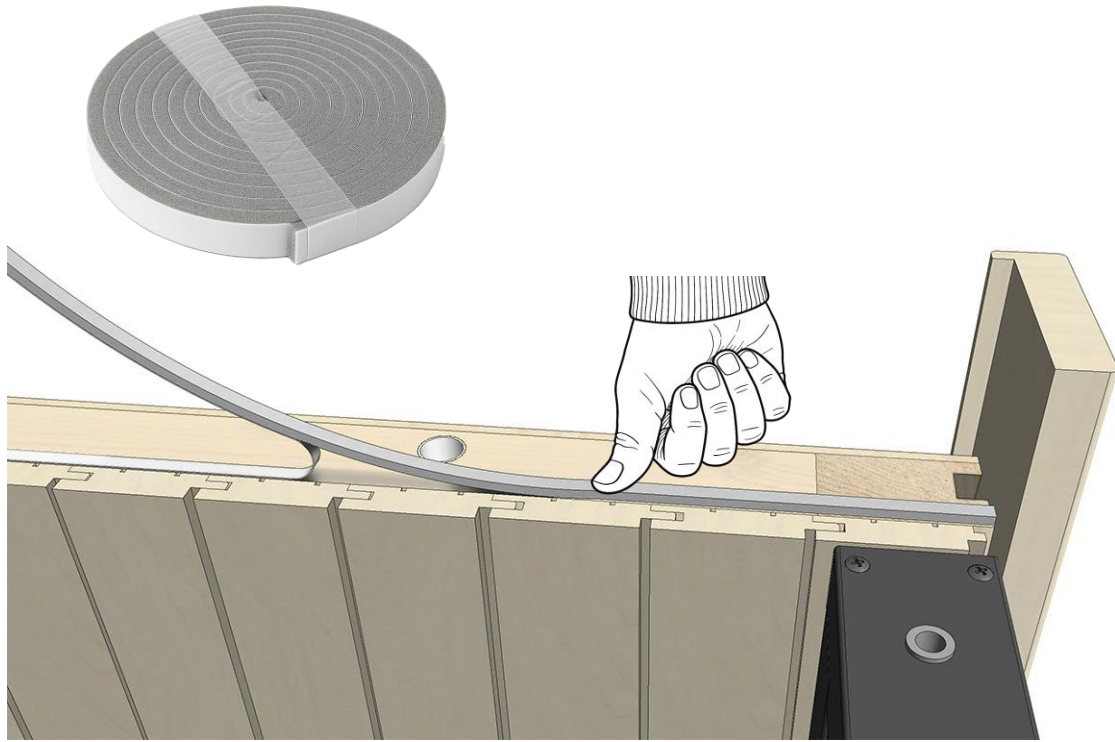



ROOF ELEMENTS

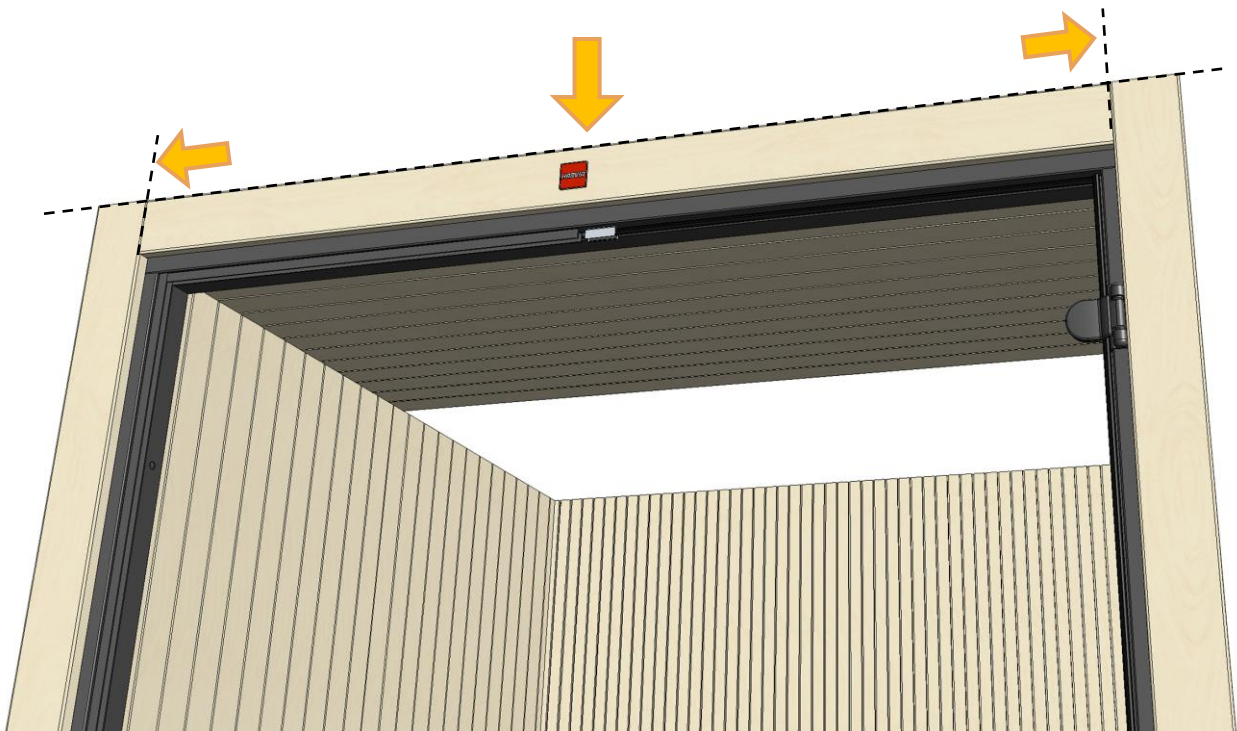
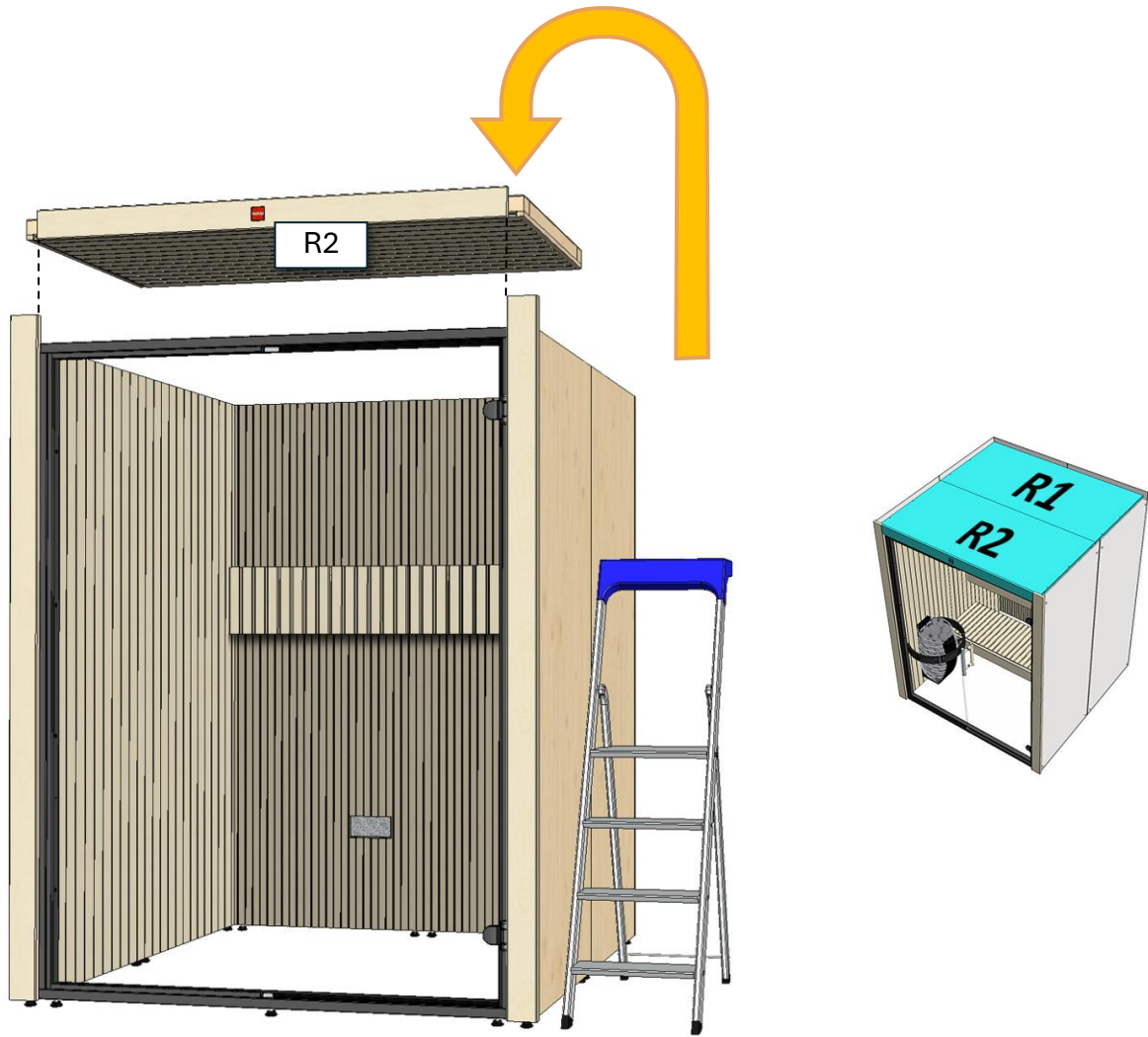



4 pcs Zn 5 * 80 mm

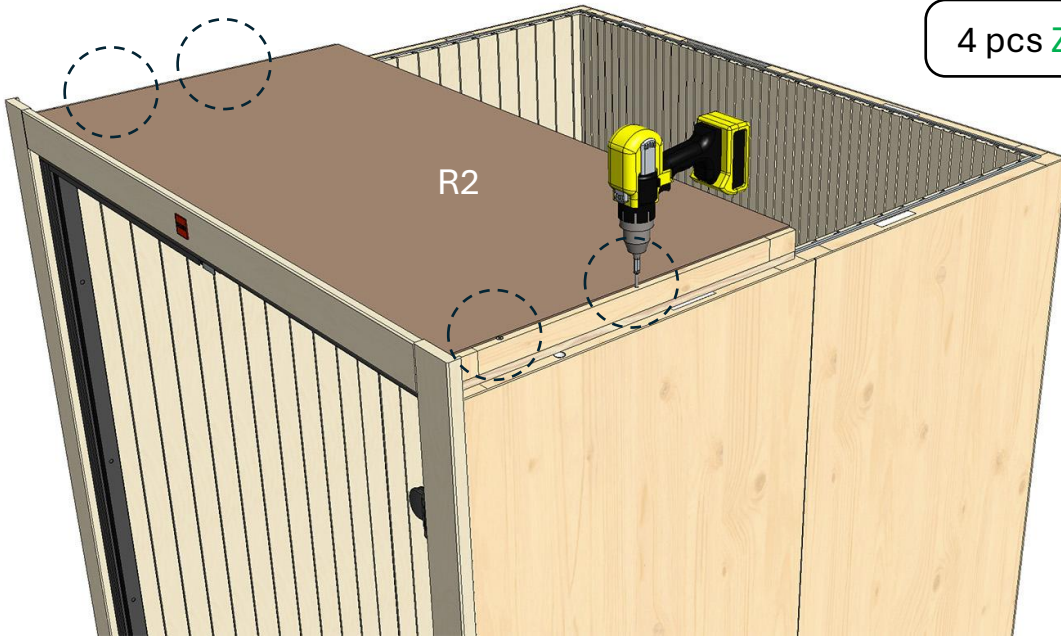

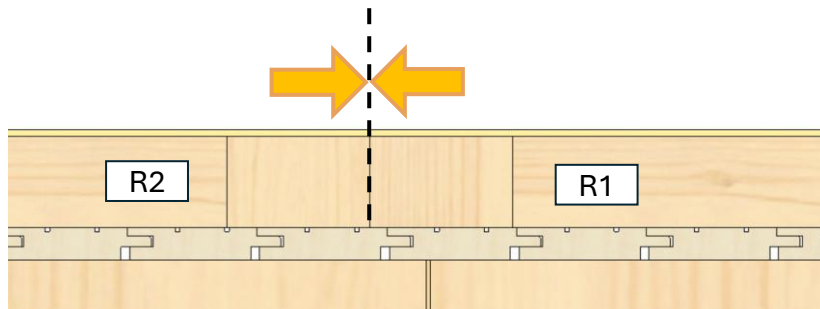
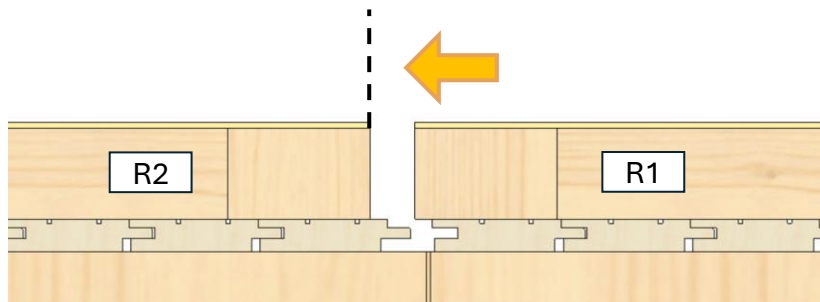
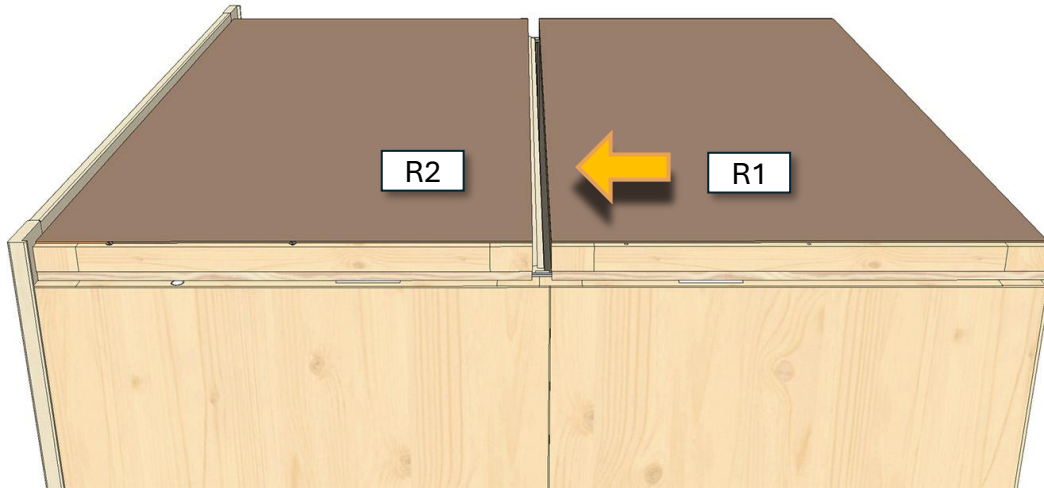

4 pcs Zn 5 * 80 mm

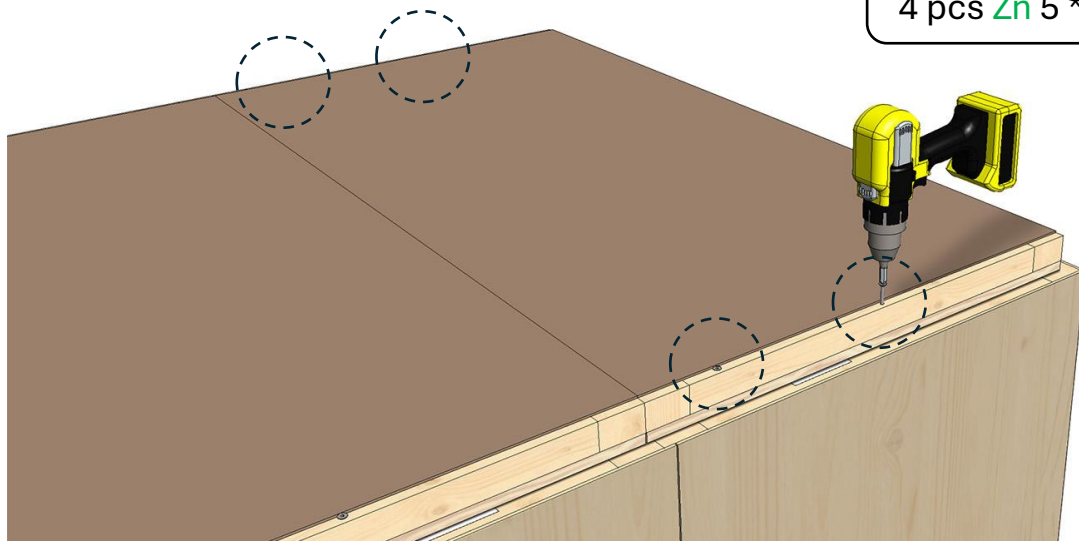

HEATER AND ELECTRICS

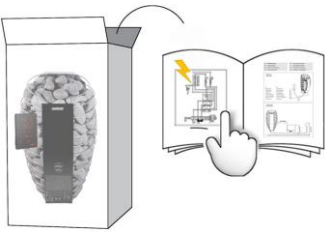

Right handed sauna

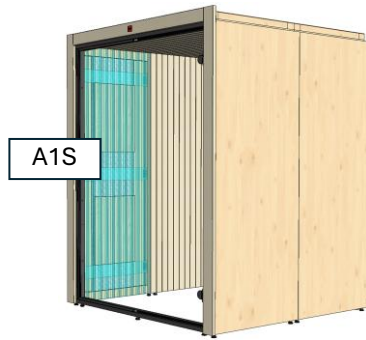

Left handed sauna

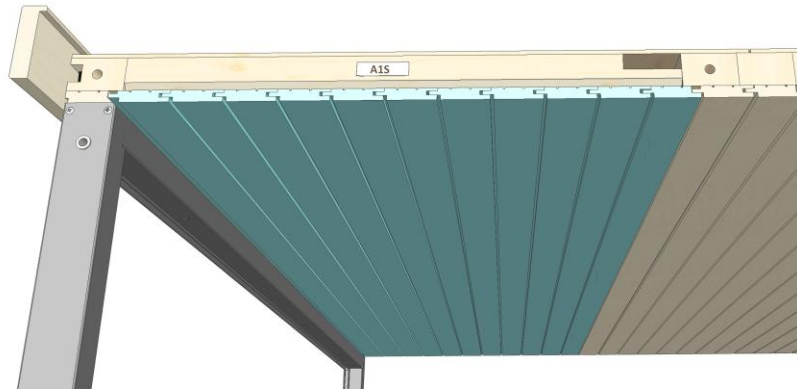

Right handed sauna

Left handed sauna

Place your temperature-sensor according instructions of Your heater on **this area!**

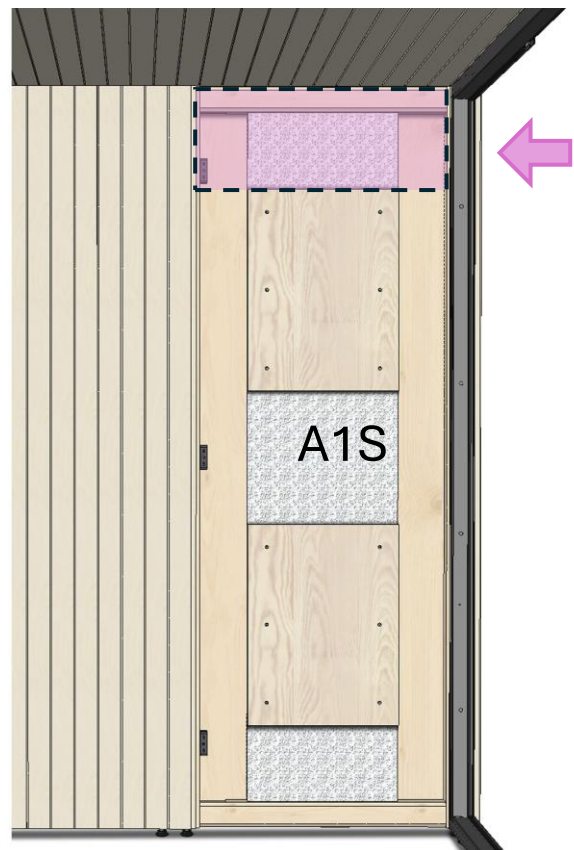
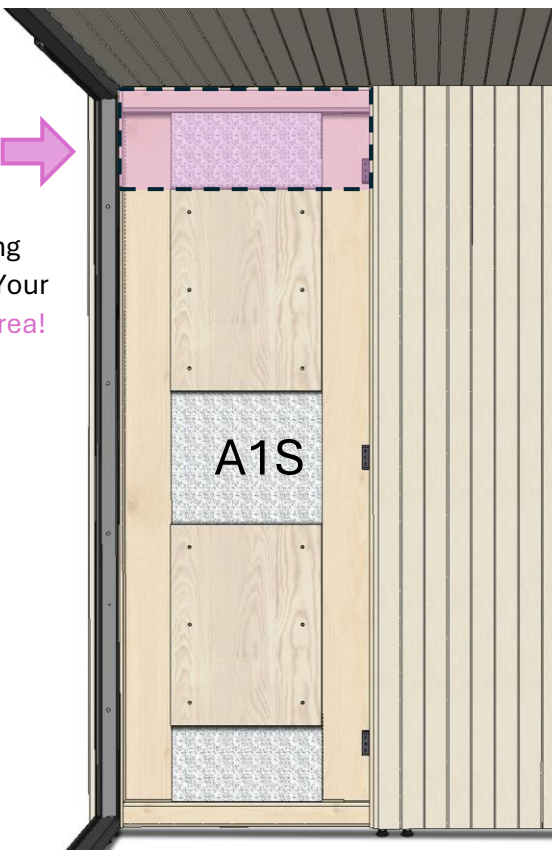



Hole for temperature
sensor cable \varnothing 8 mm

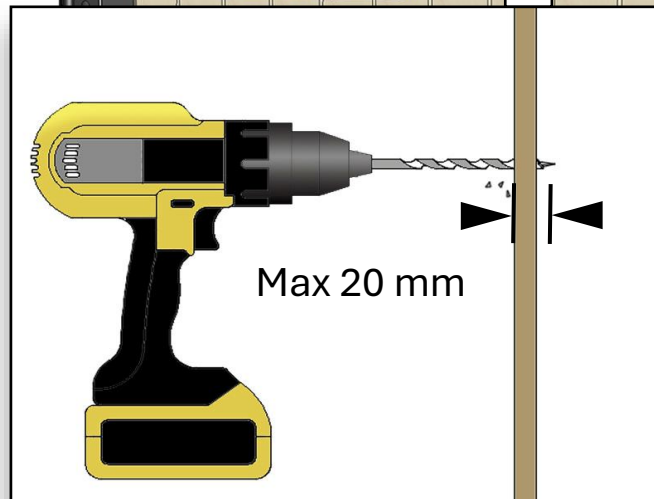
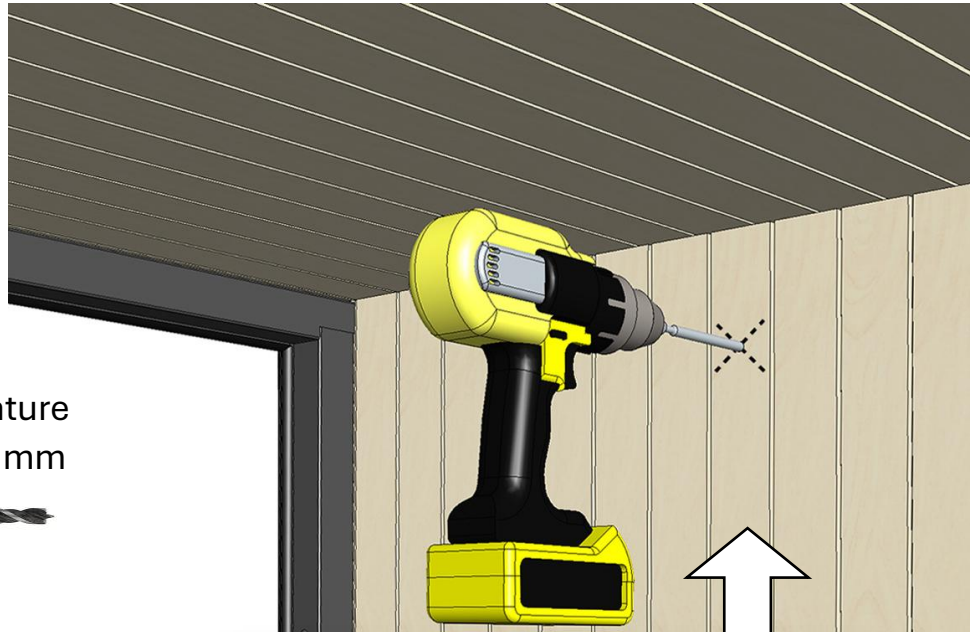

Hole for heater power
cable \varnothing 20 mm

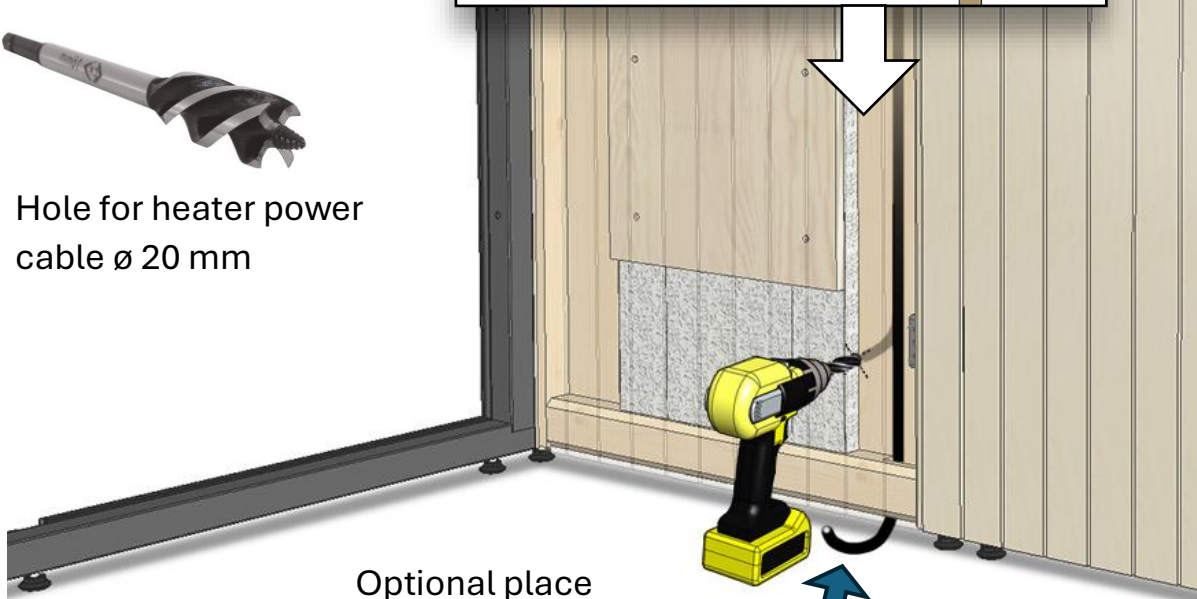

Optional place
for bringing heater cable out.

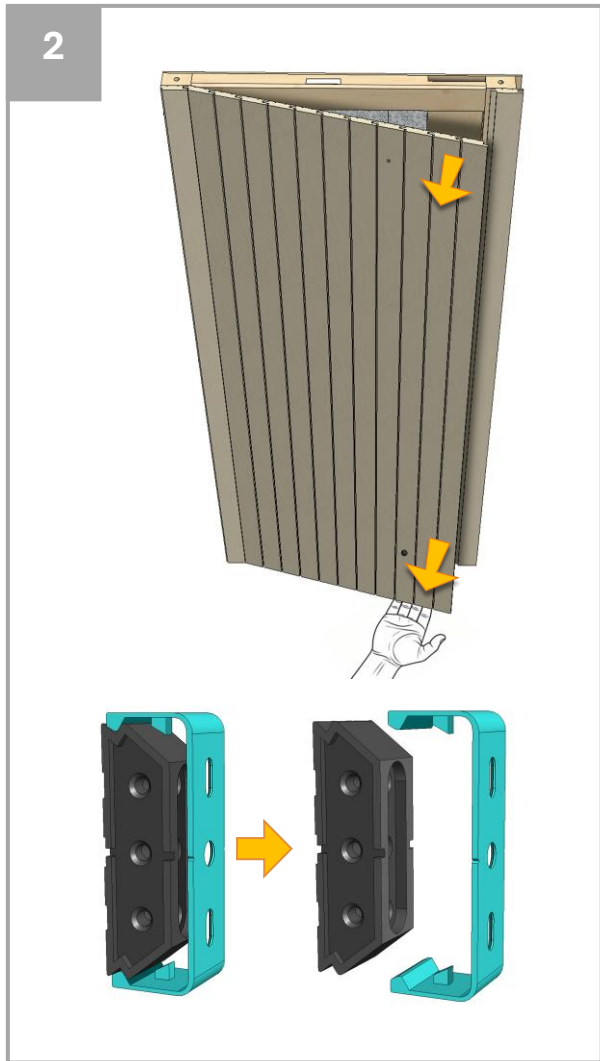
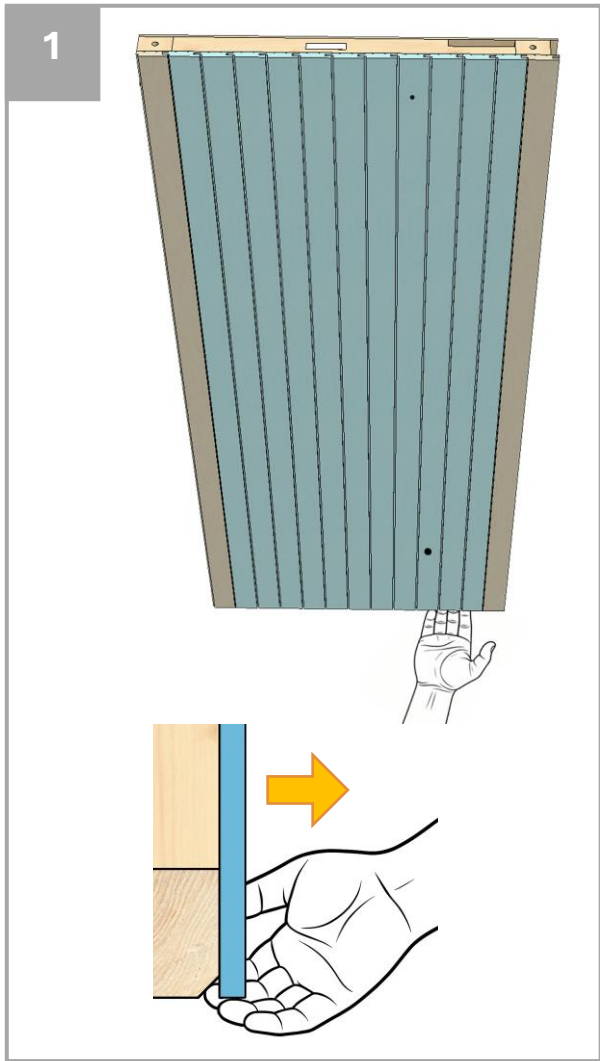

CABLE FOR HEATER

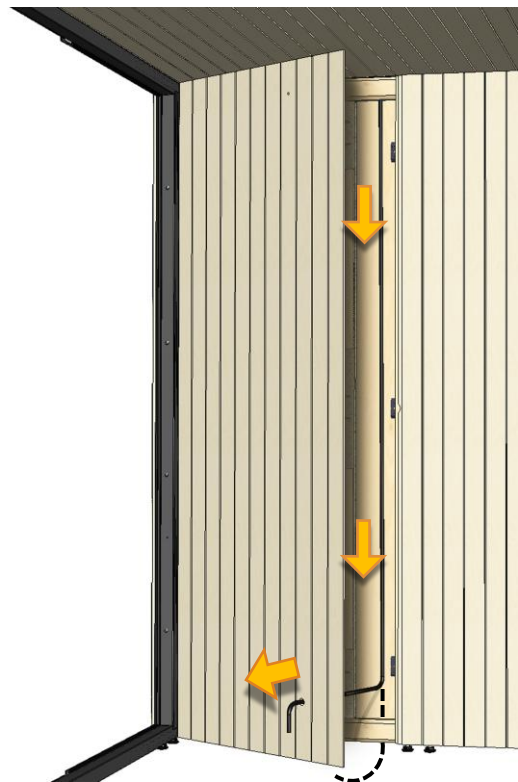
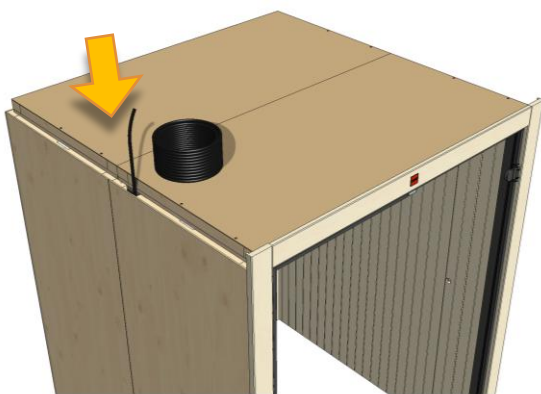



TEMPERATURE SENSOR

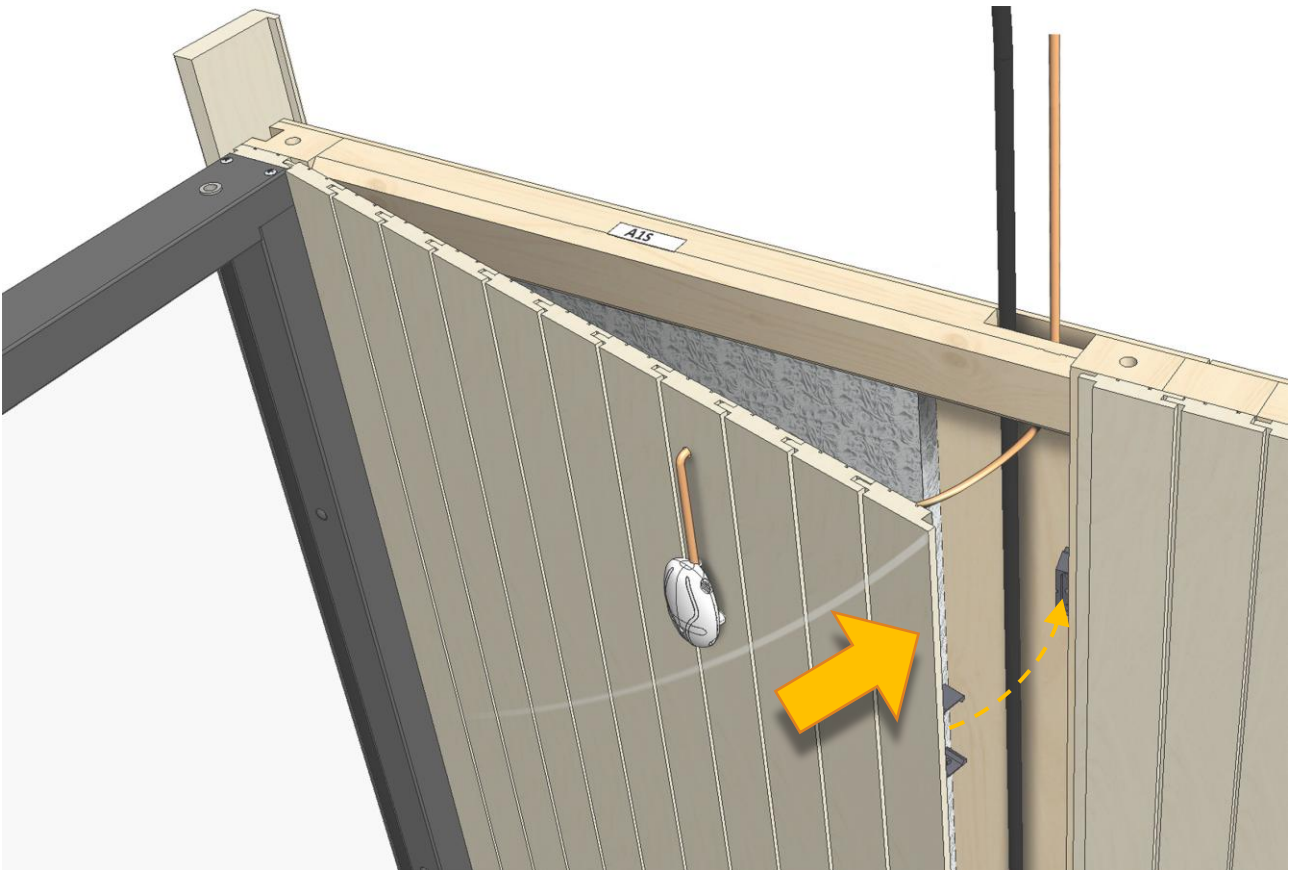
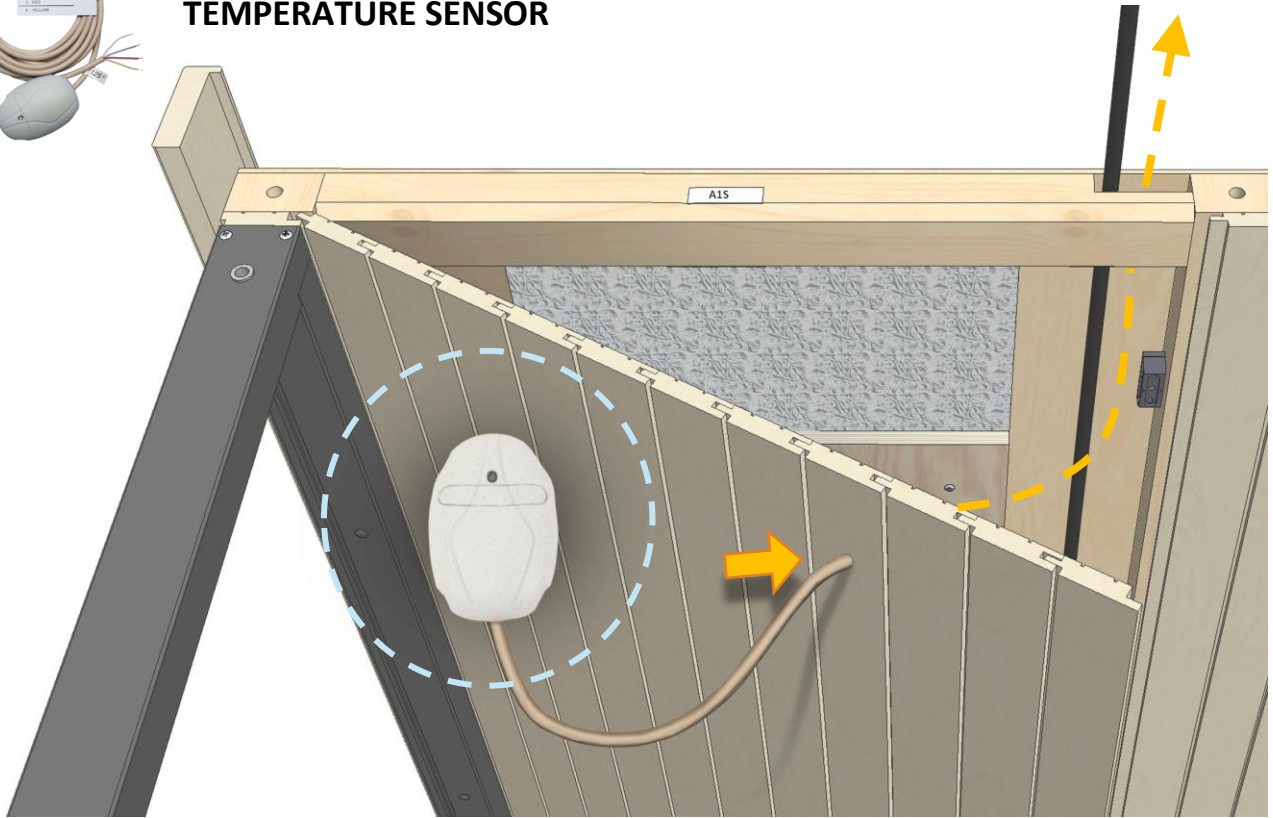

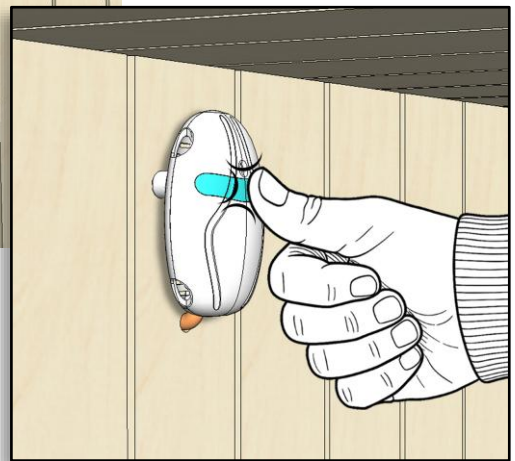
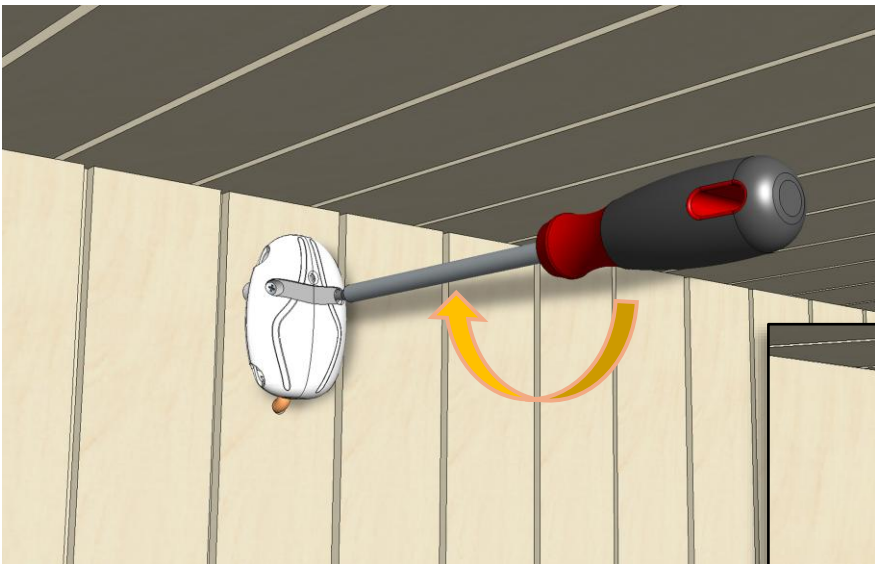
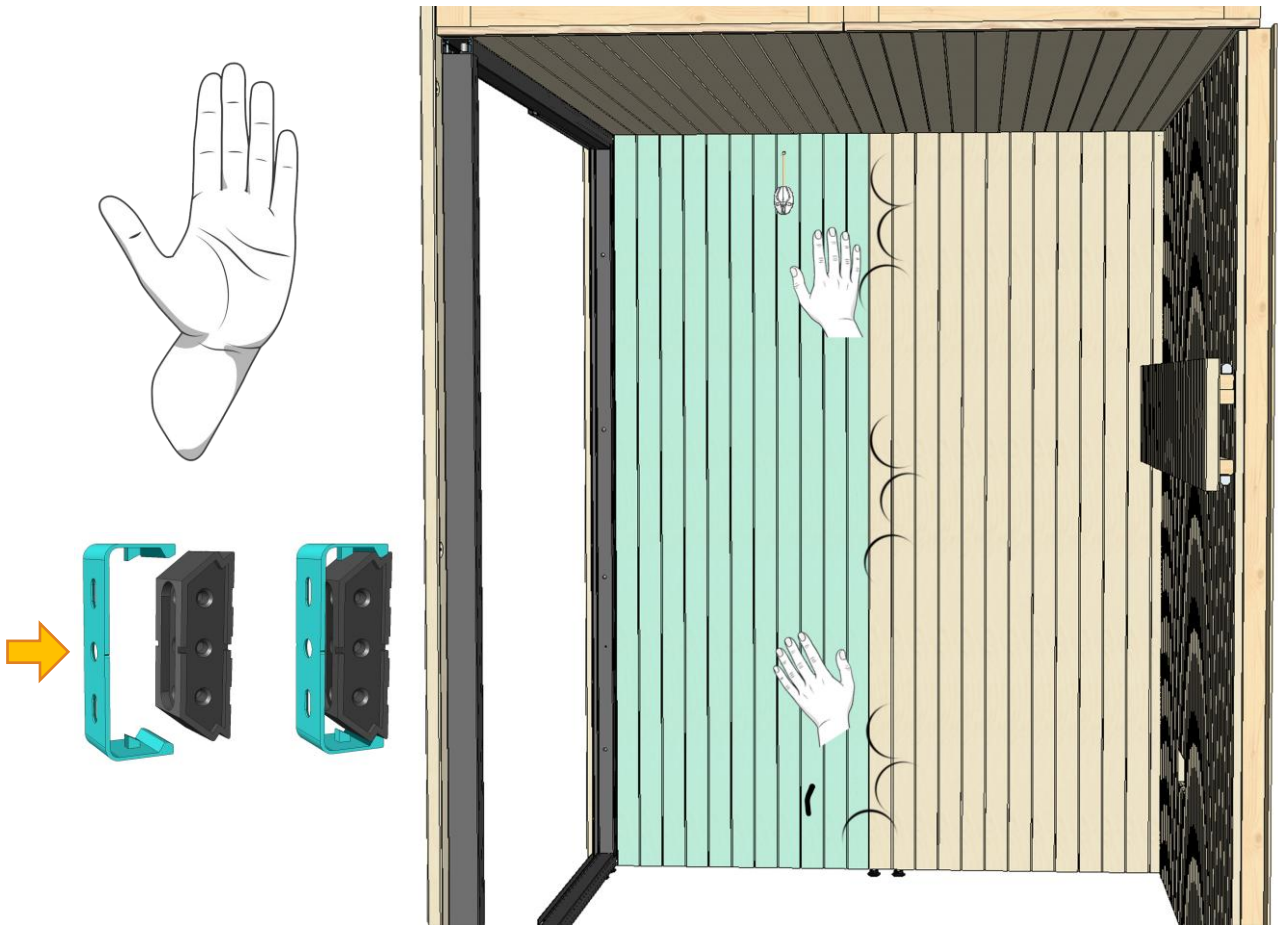

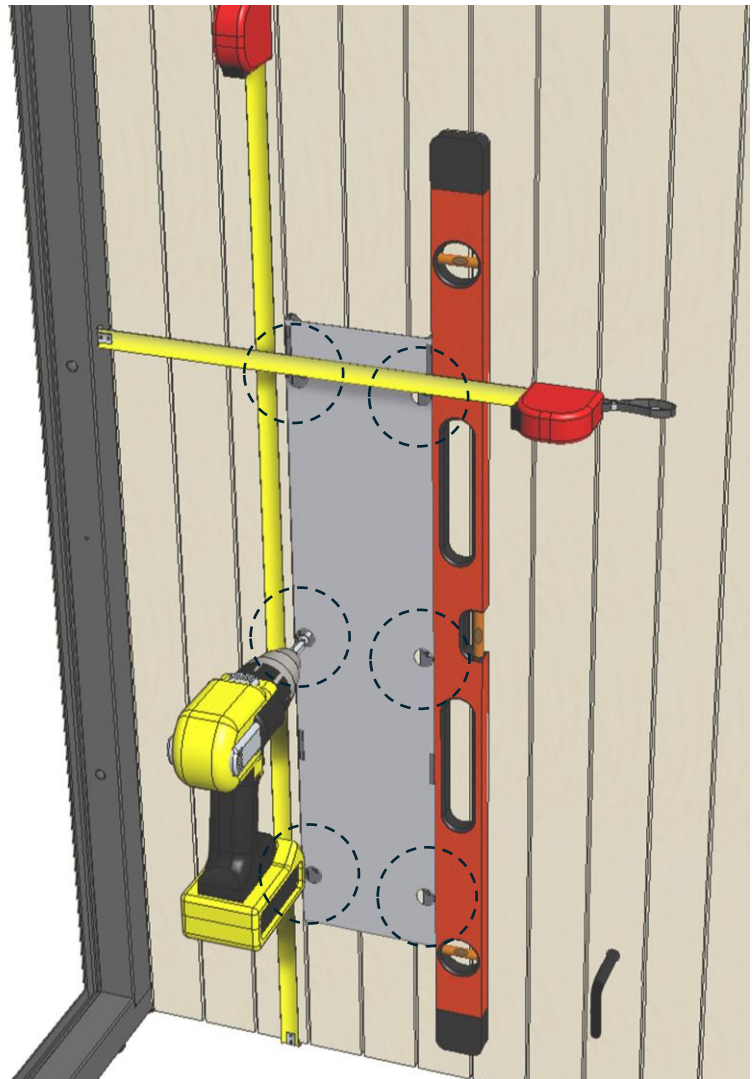
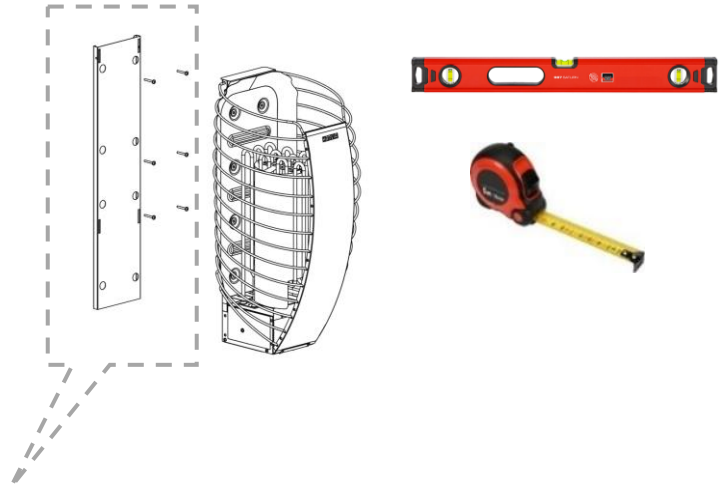
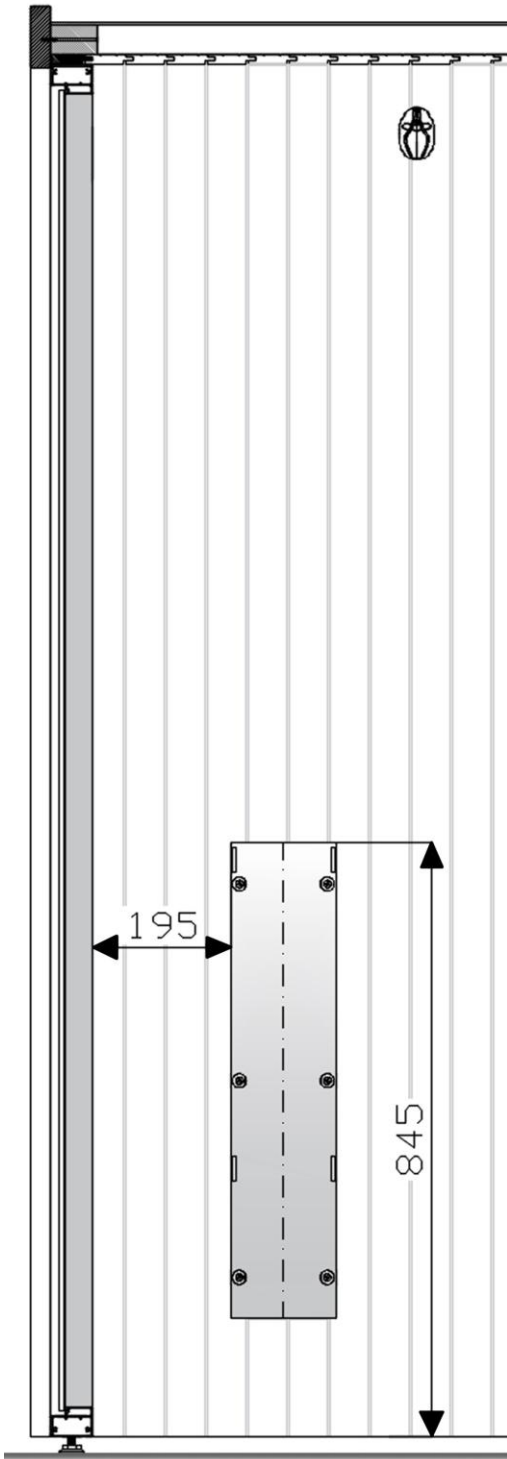

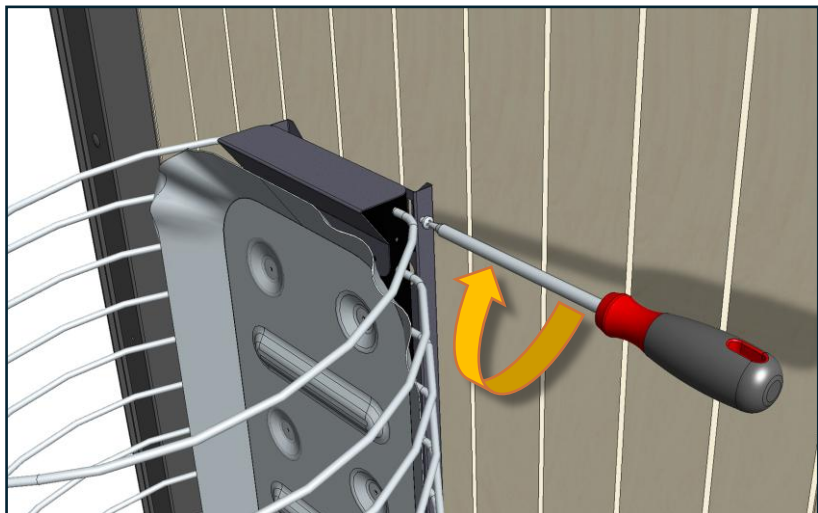
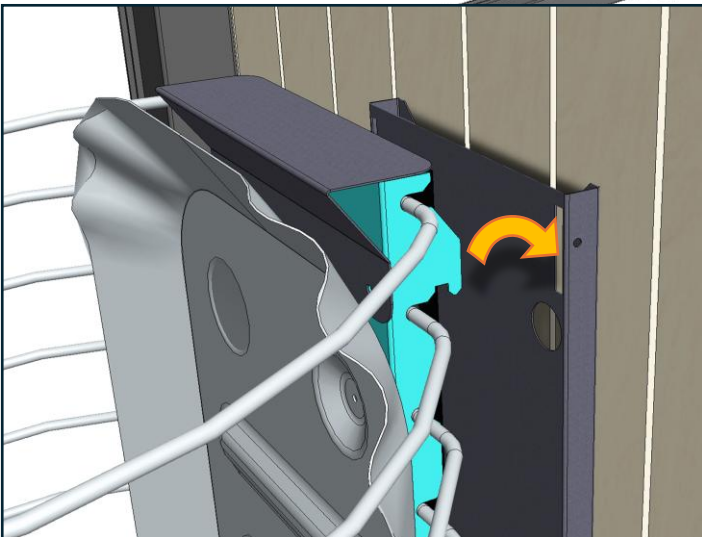
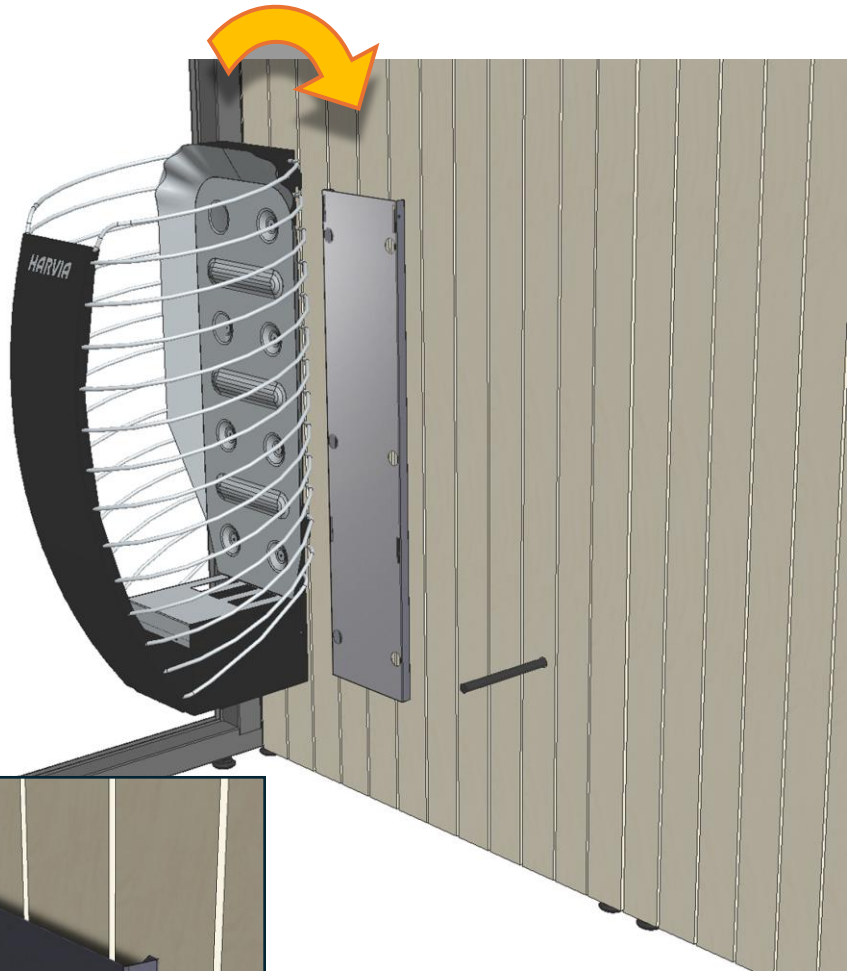
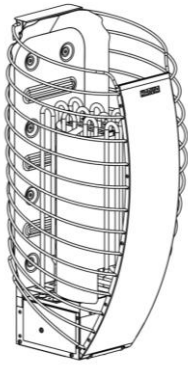

HEATER CONNECTIONS

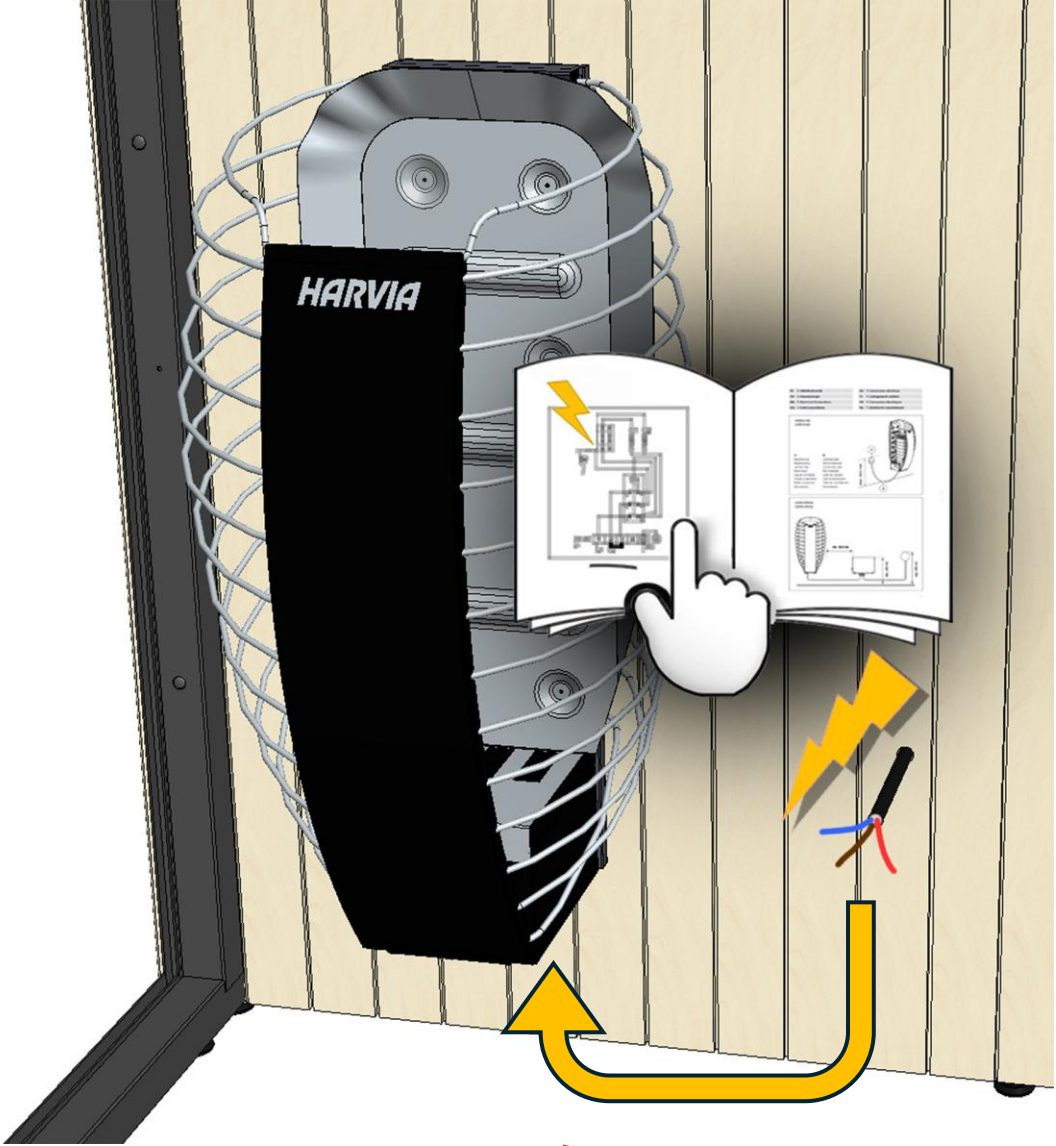

NOTICE!
AUTHORIZED
ELECTRICIAN ONLY
CAN INSTALL
HEATER!



XENIO CONTROL PANEL

Fenix control panel -> p. 43

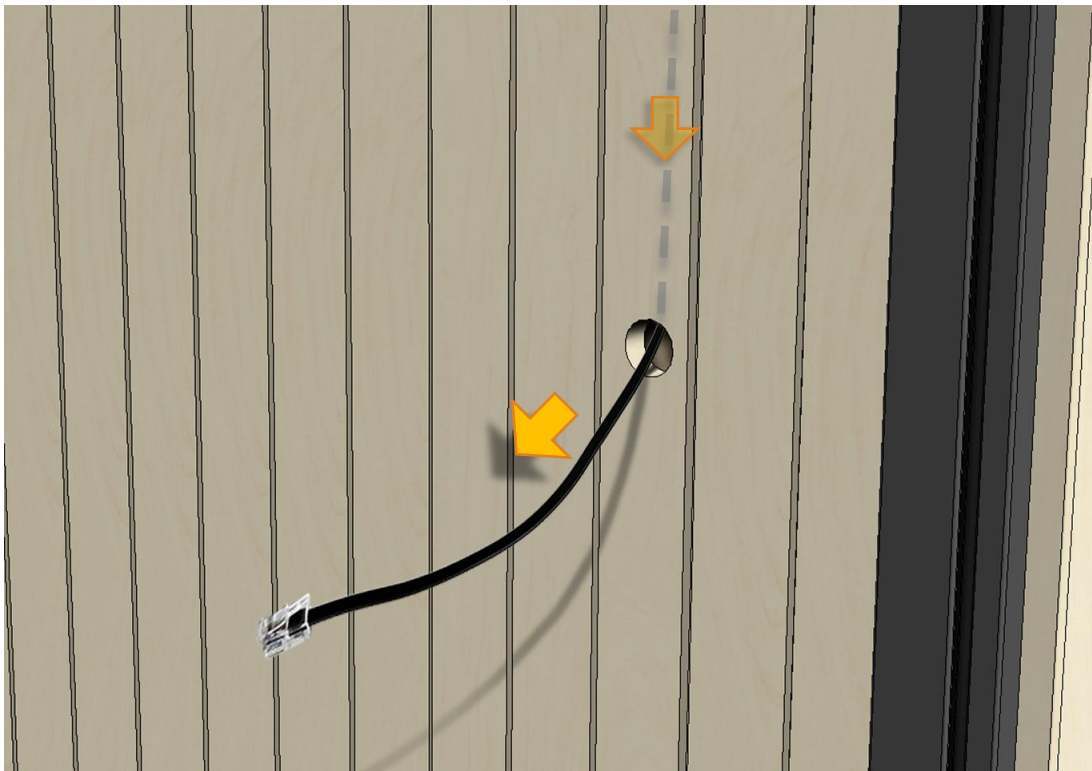

Xenio

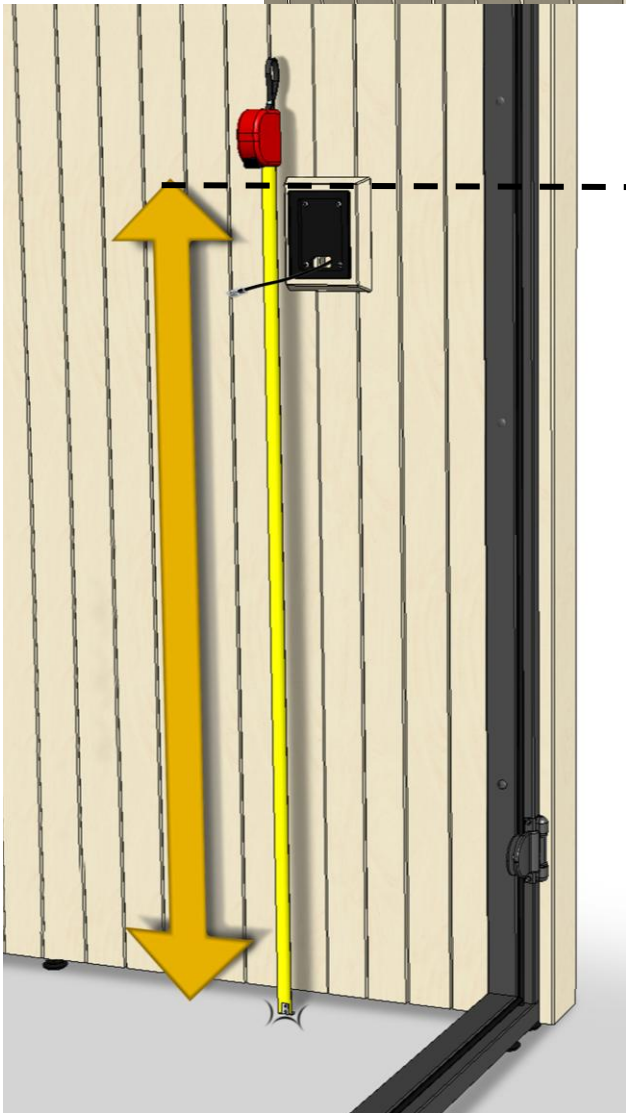
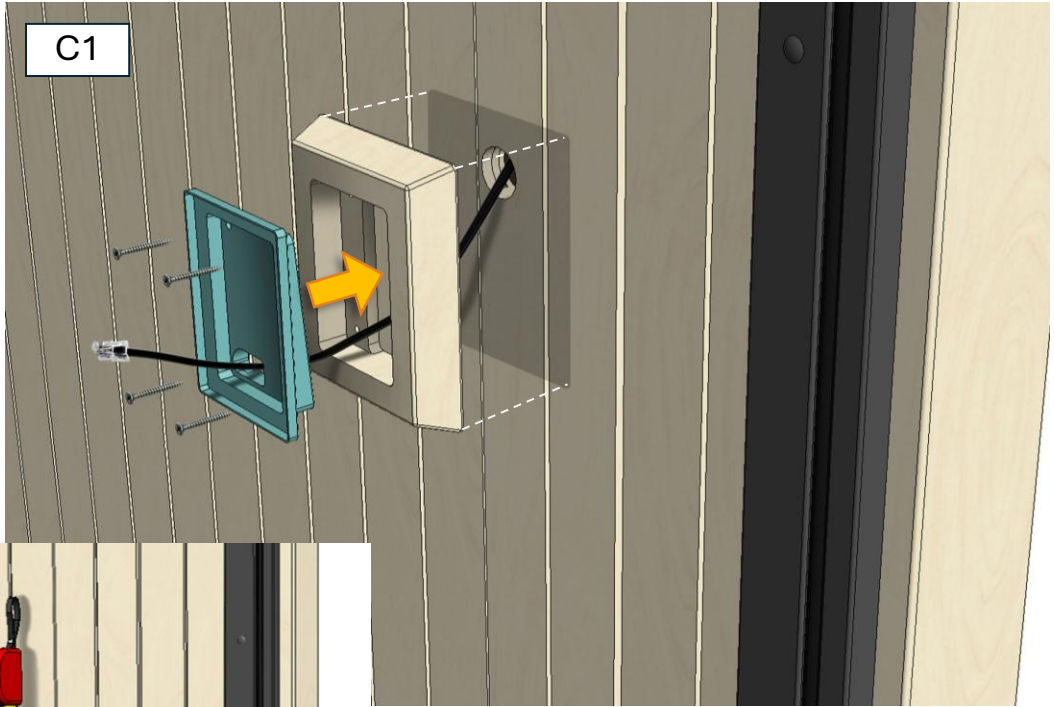
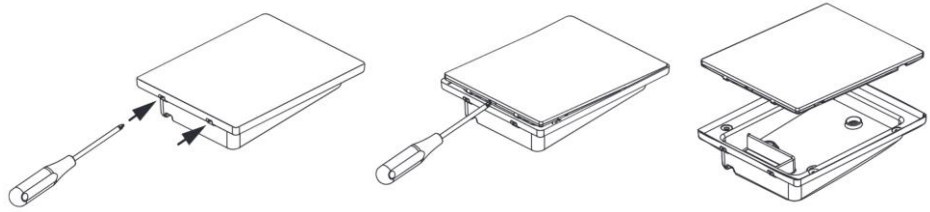

NOTICE! MAX HEIGHT 1100 mm



4 pcs Zn 3 * 25 mm

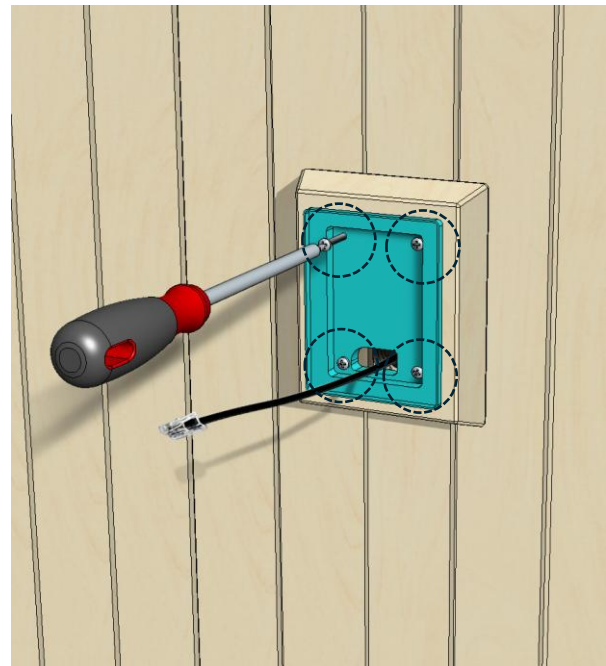

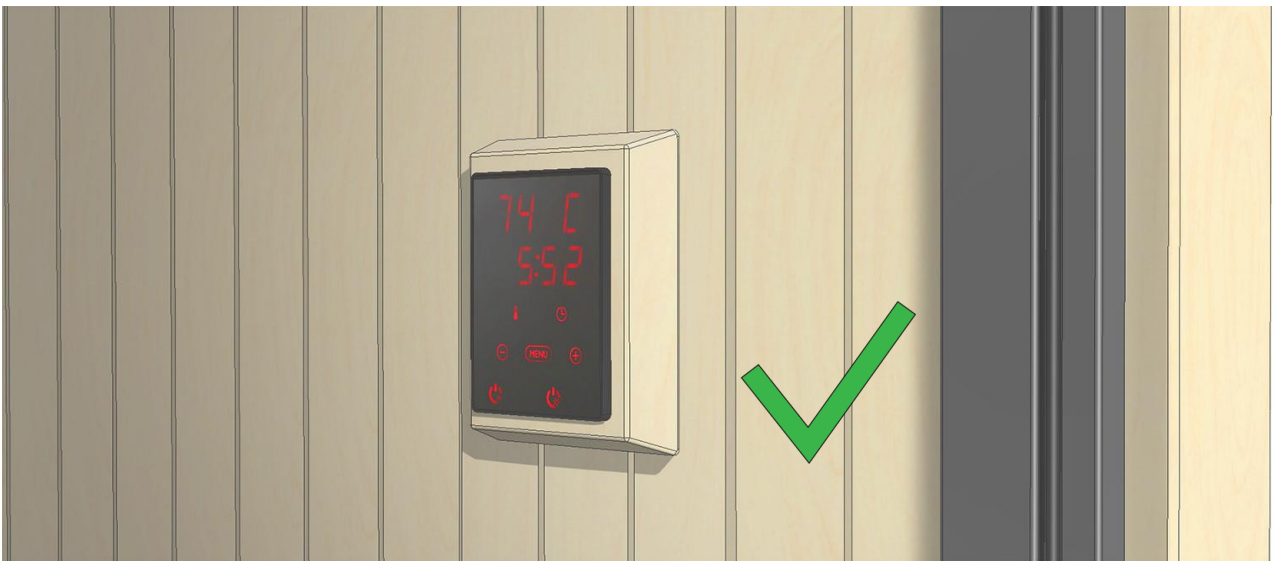
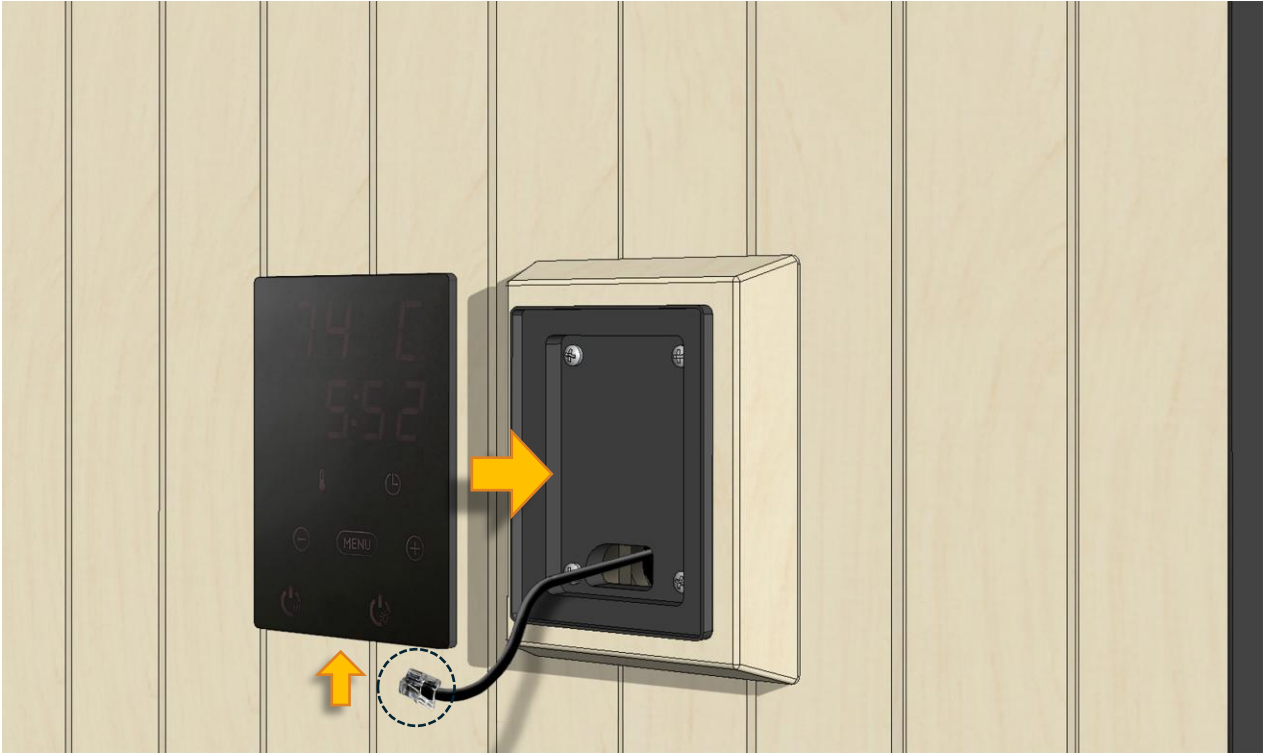

FENIX CONTROL PANEL

Xenio control panel -> p. 40

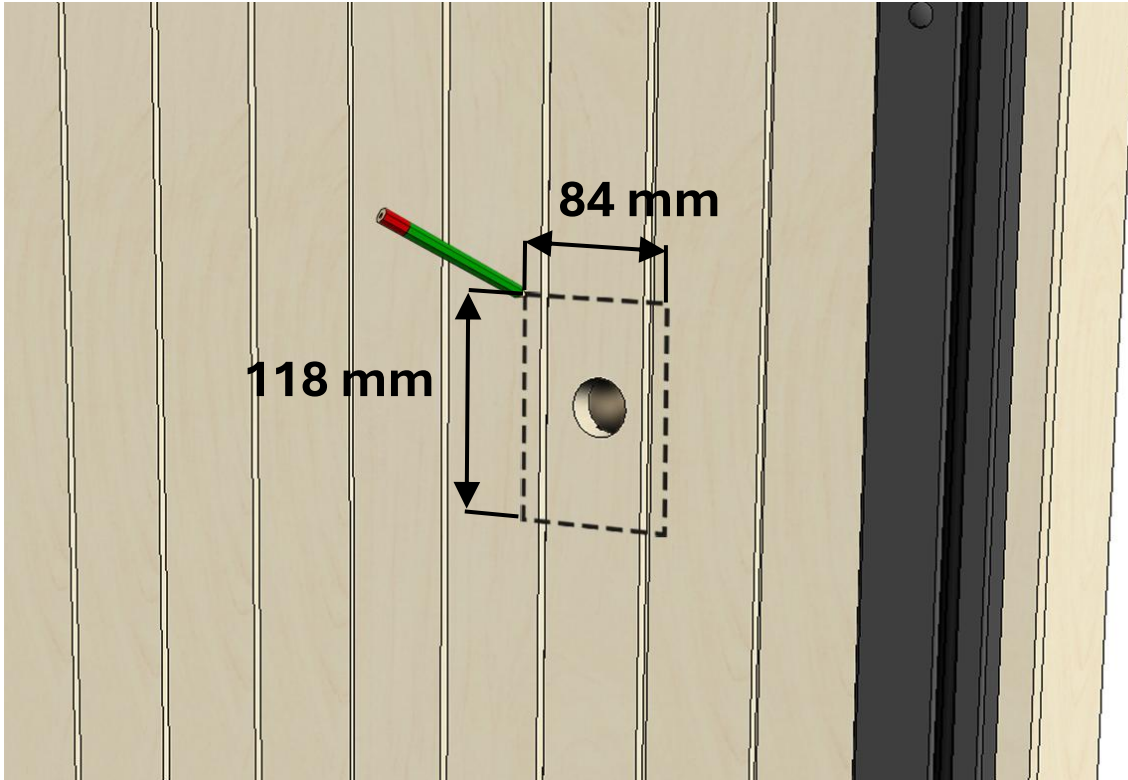

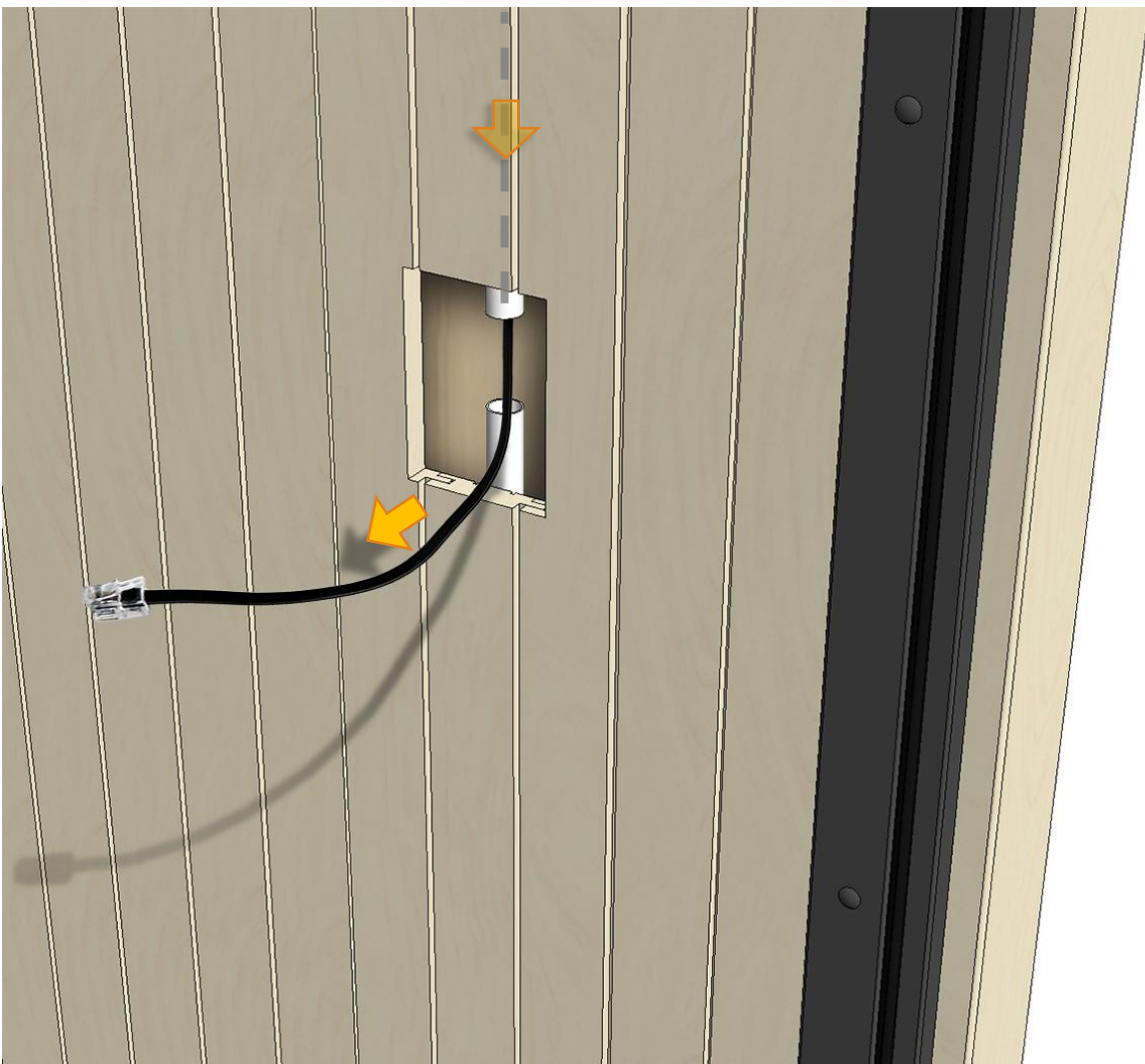
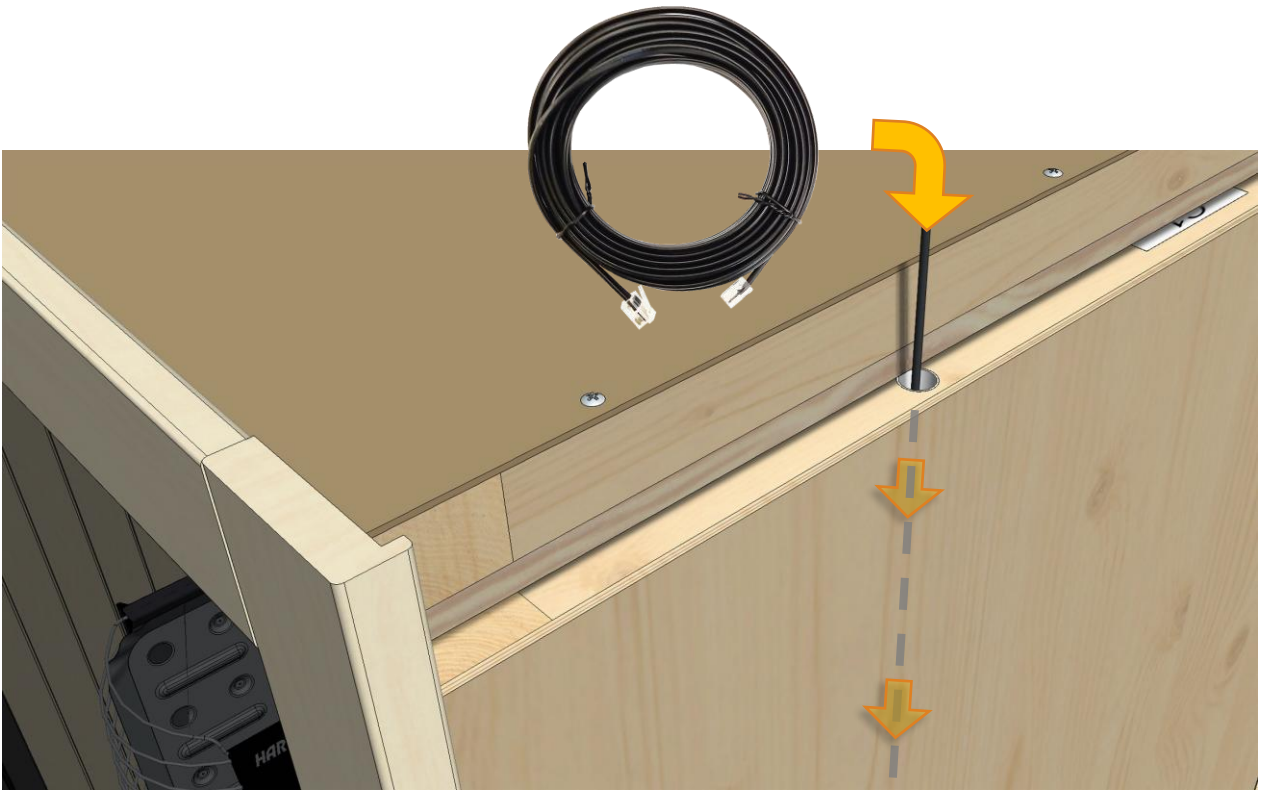

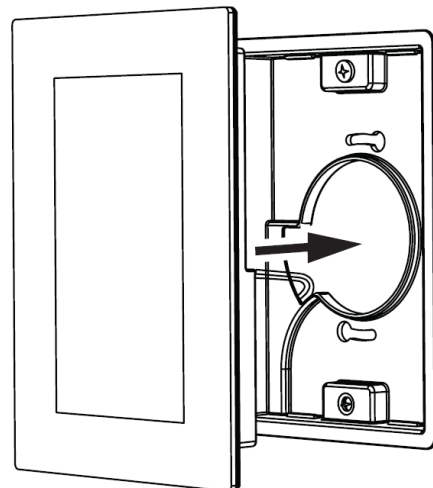
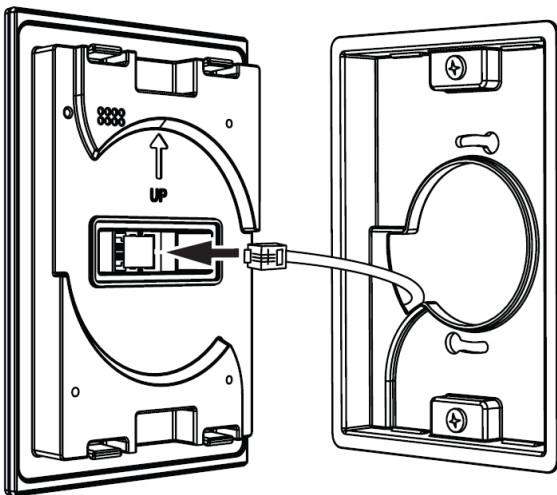
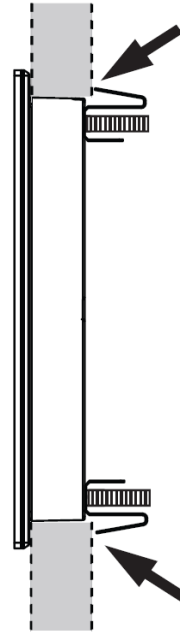
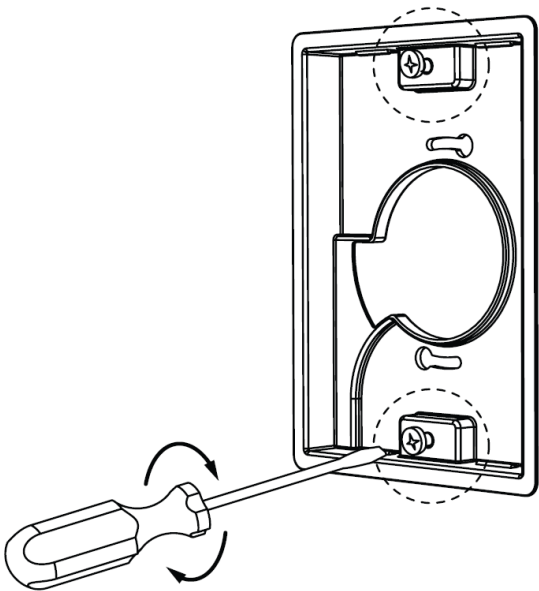
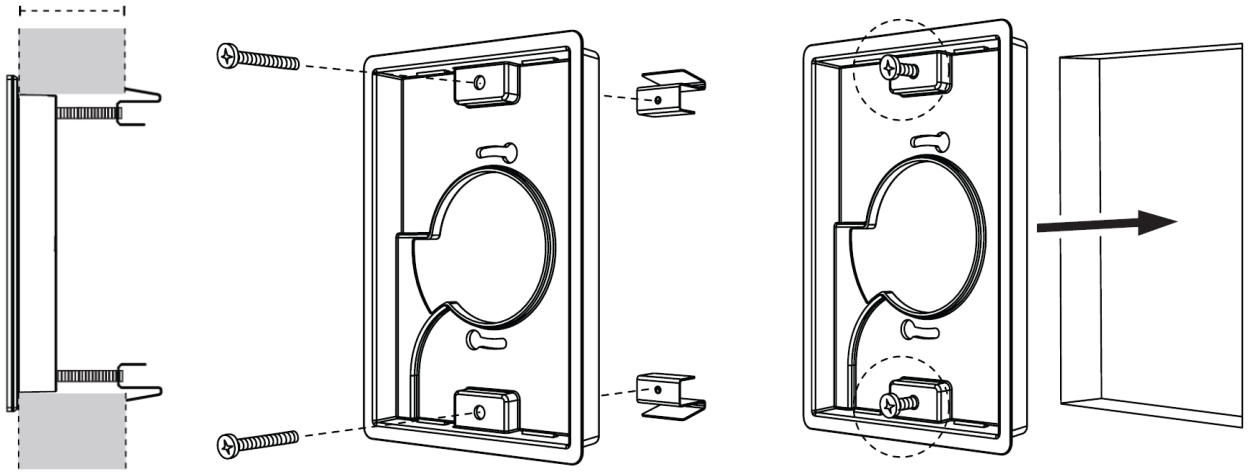



VENTILATION



402135

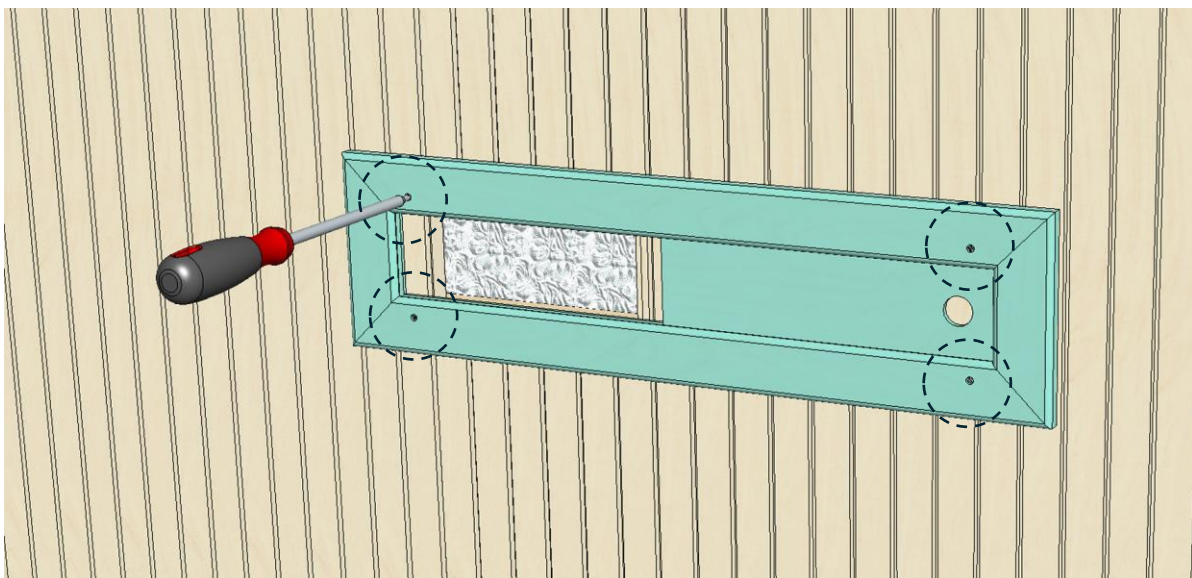
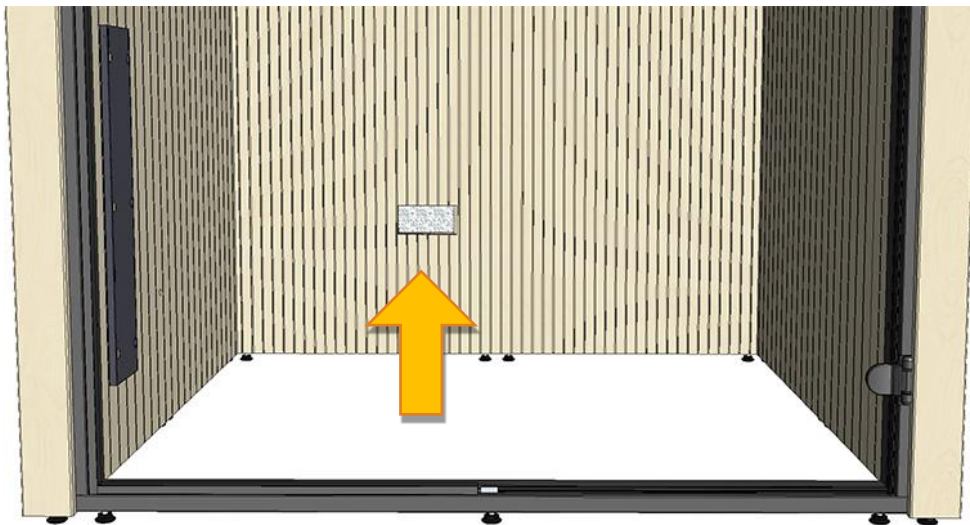



BENCHES, Small

(URW1212FG / URB1212FG)

Medium -> p.53

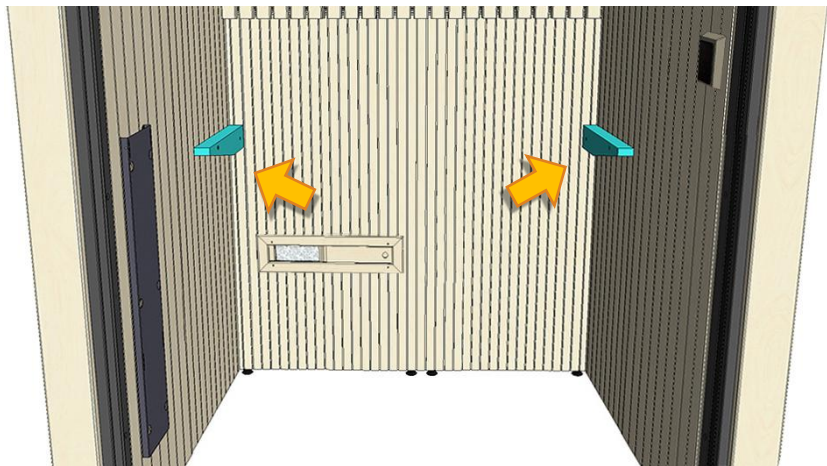
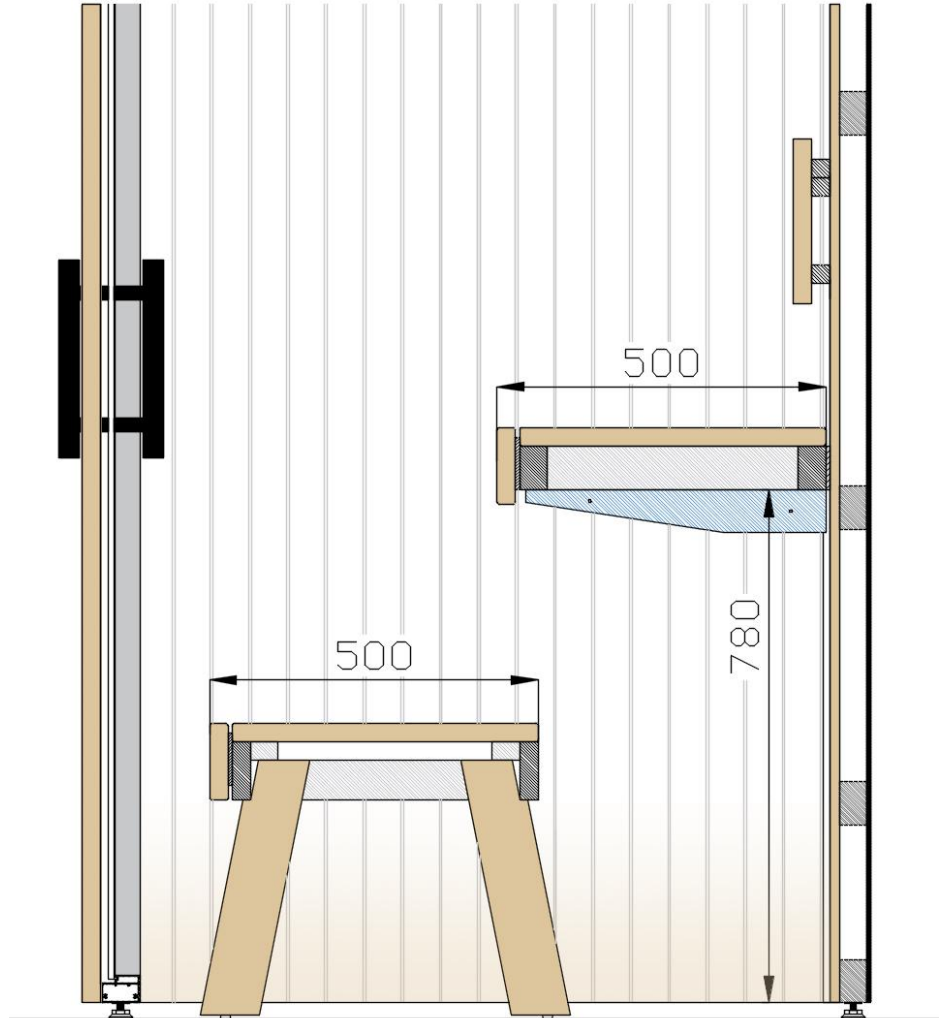

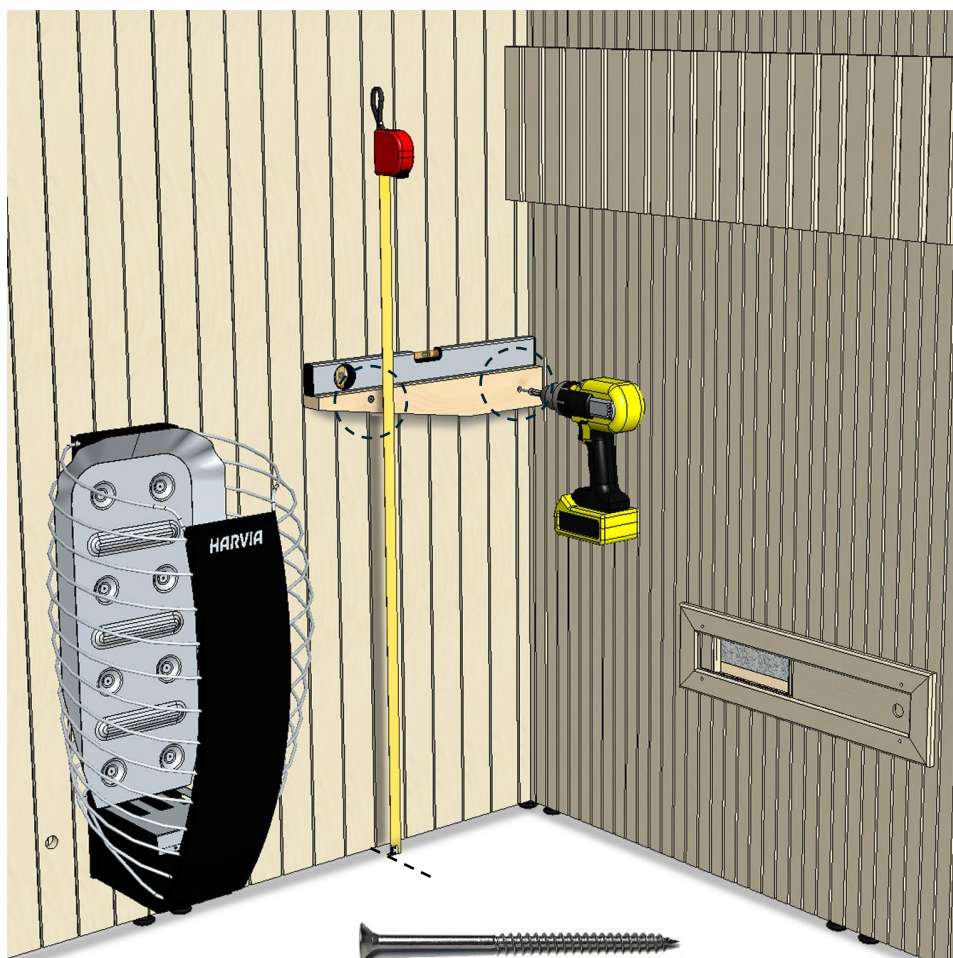

4 pcs Zn 6 * 100 mm

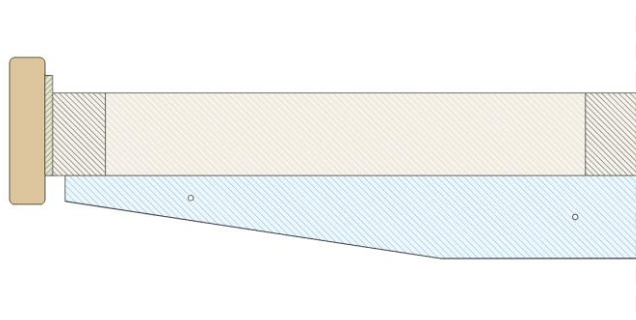
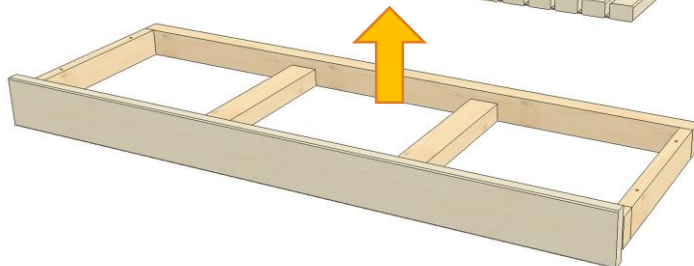

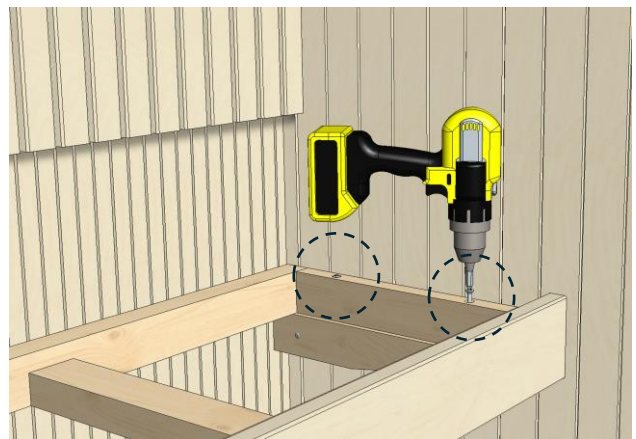
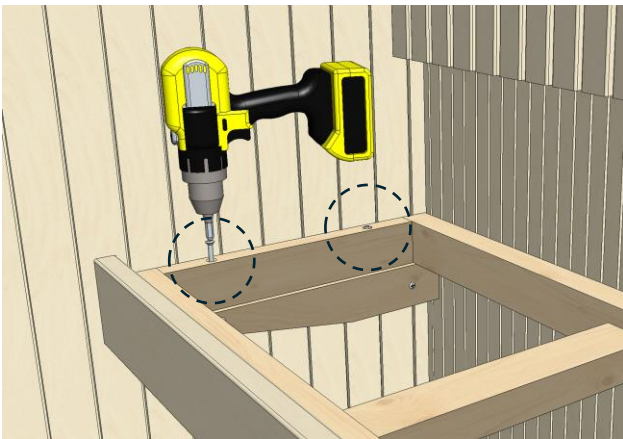

4 pcs Zn 5 * 80 mm

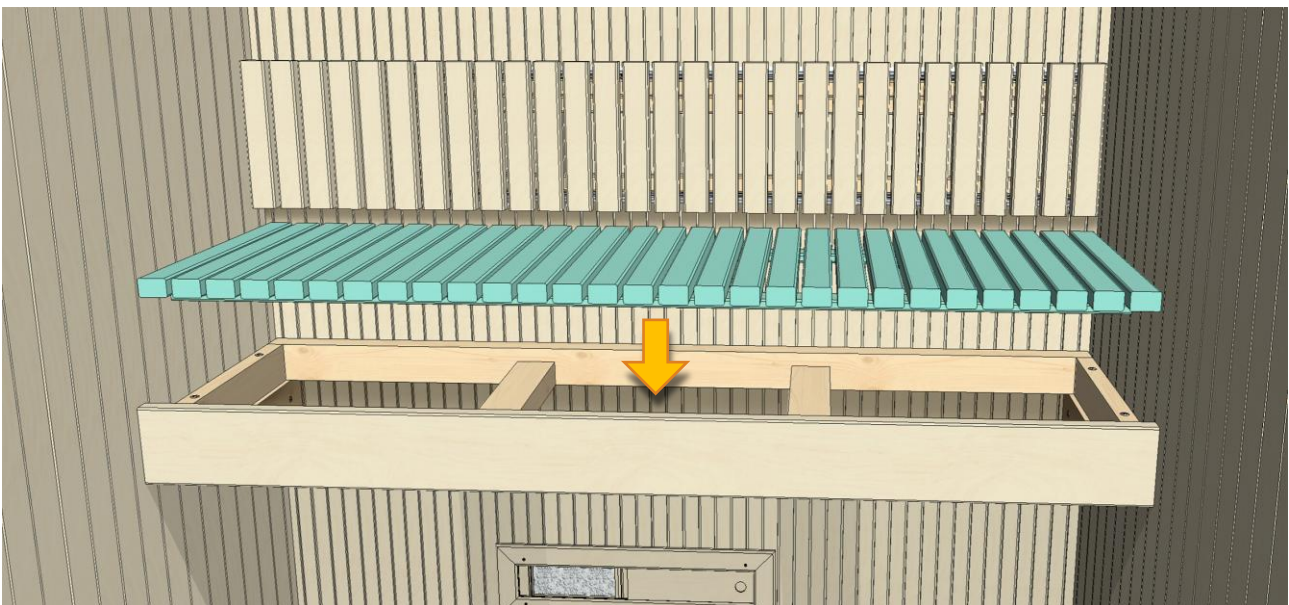

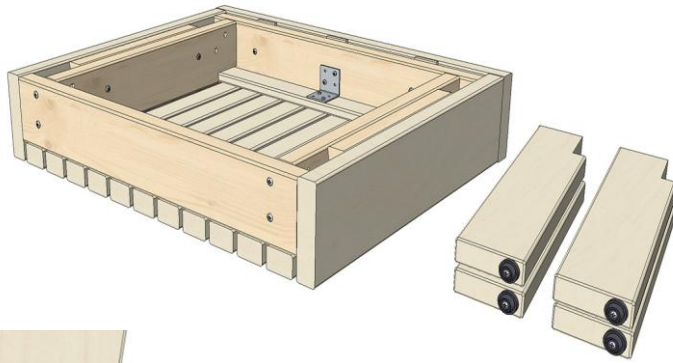

NOTICE! GLUE!

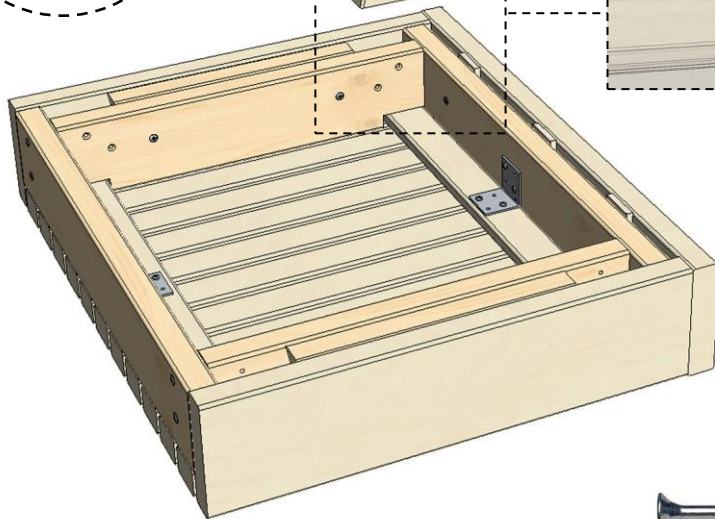
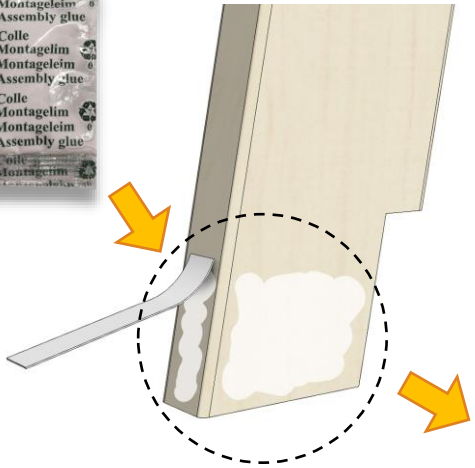

2 pcs Zn 5 * 50 mm

X 4

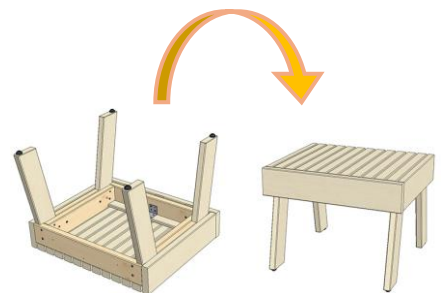
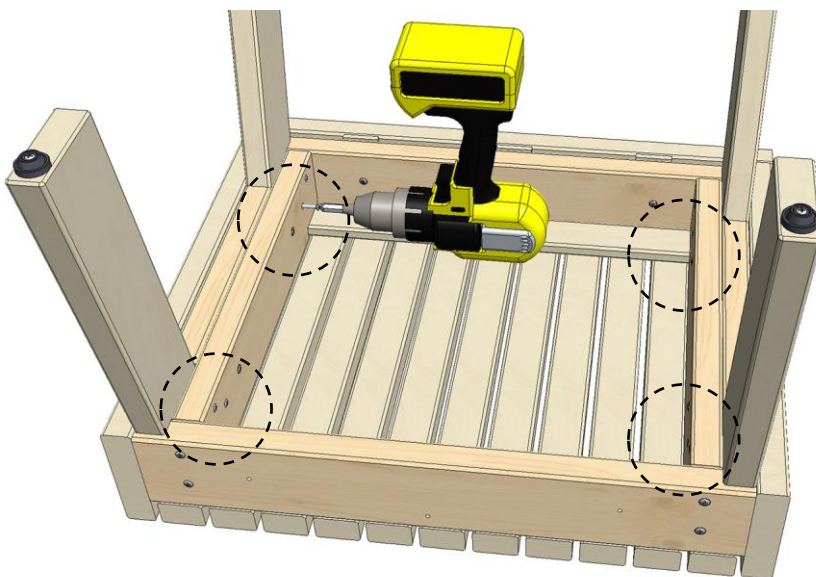



BENCHES, Medium

(URW1616FG / URB1616FG)

Small -> p.49

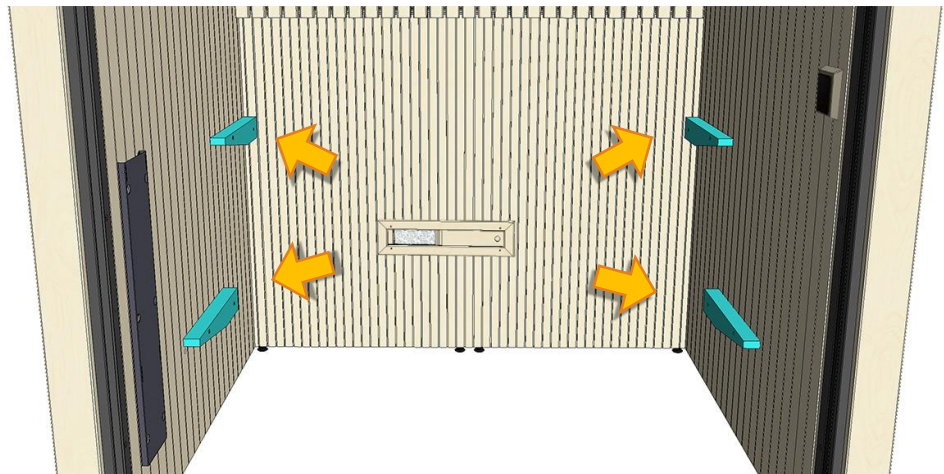
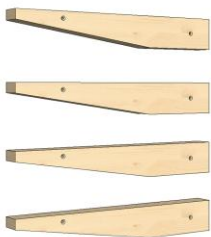
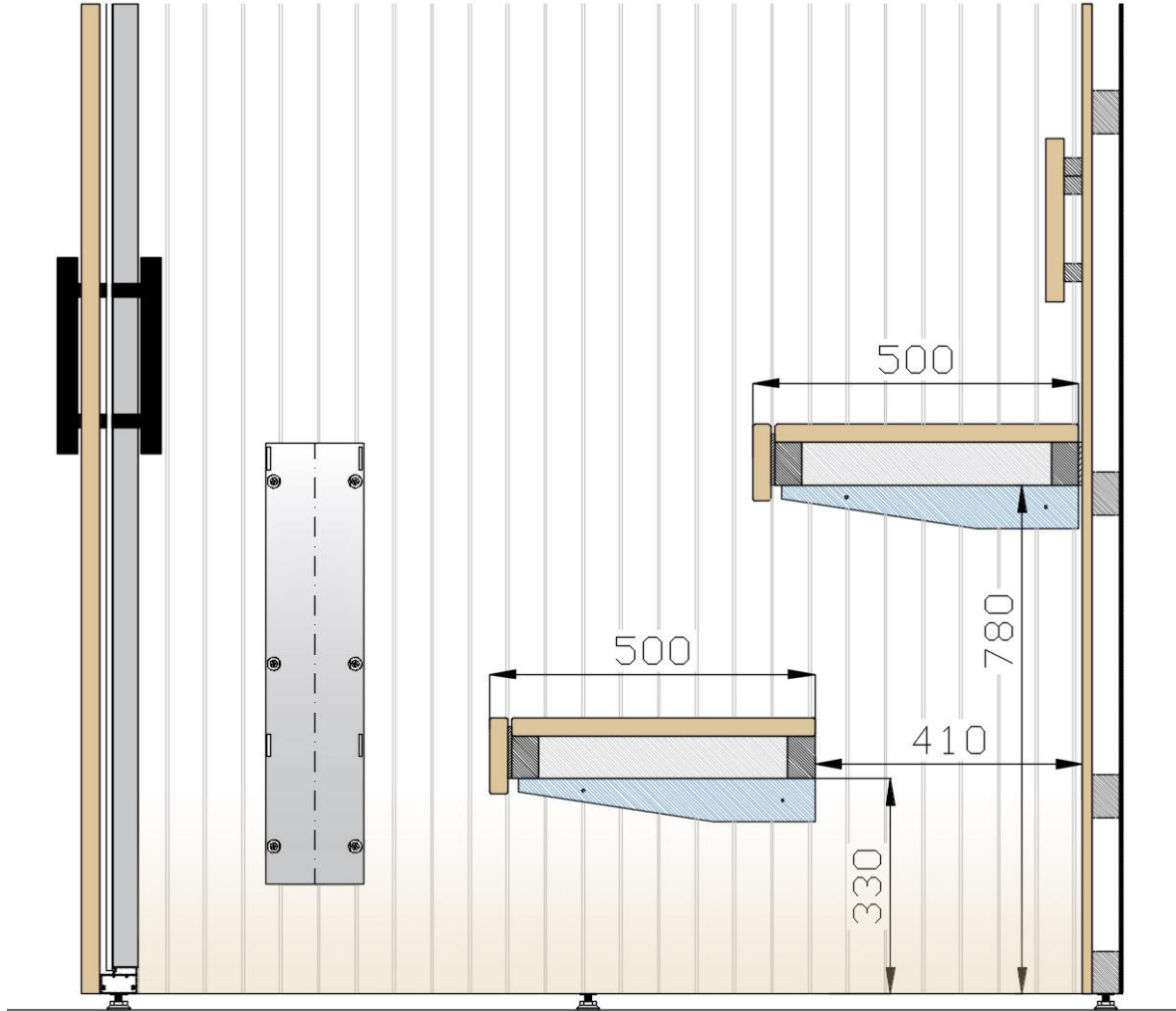
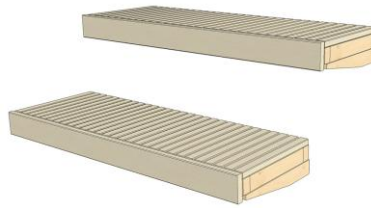

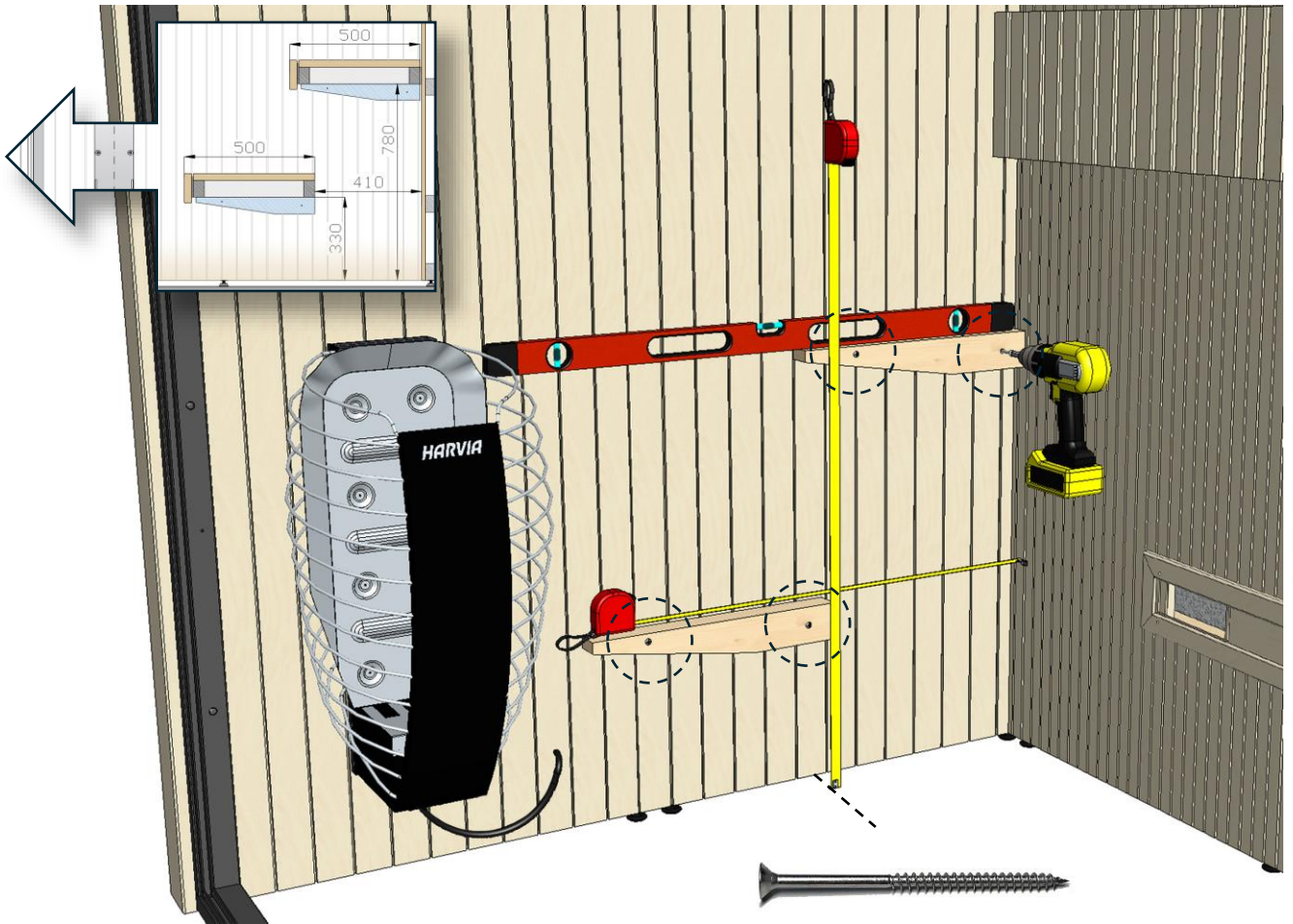

8 pcs Zn 6 * 100 mm

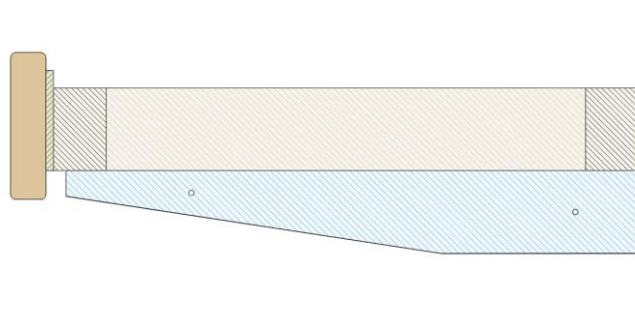
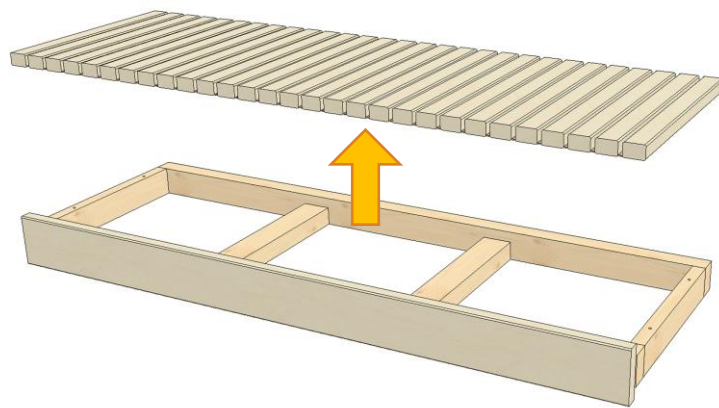

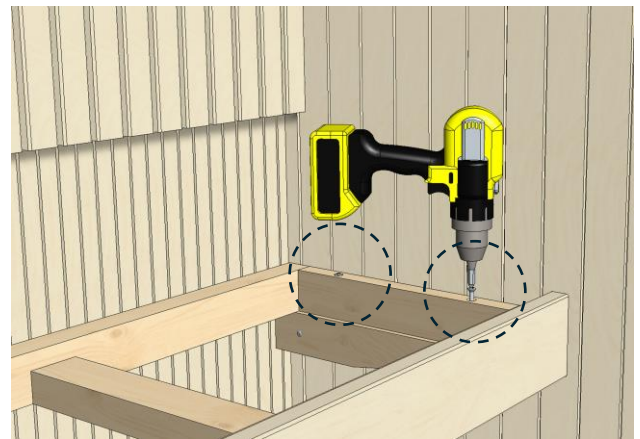
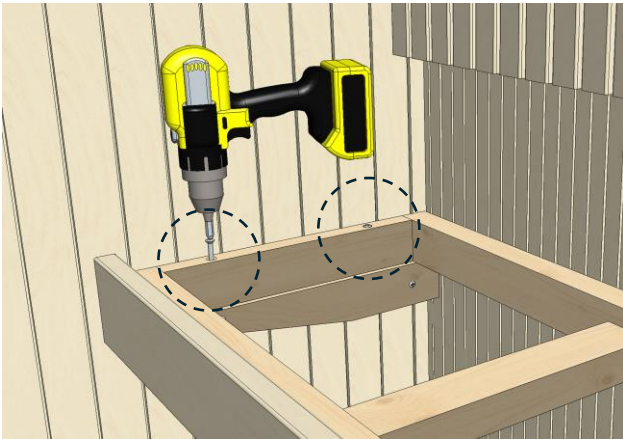
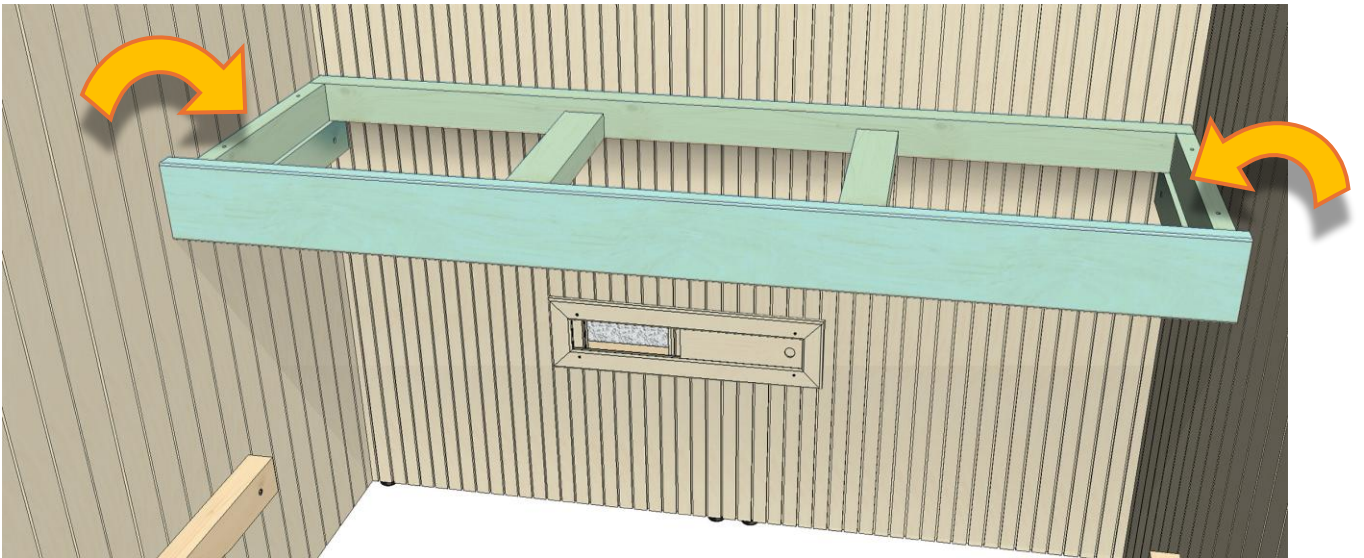

4 pcs Zn 5 * 80 mm

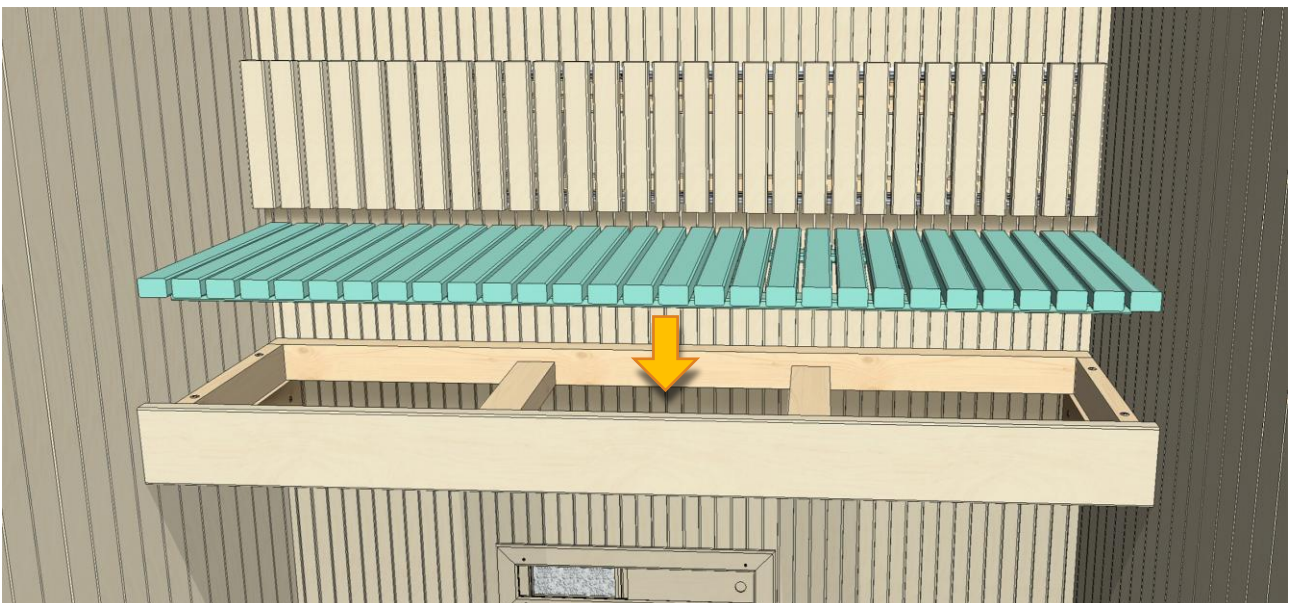

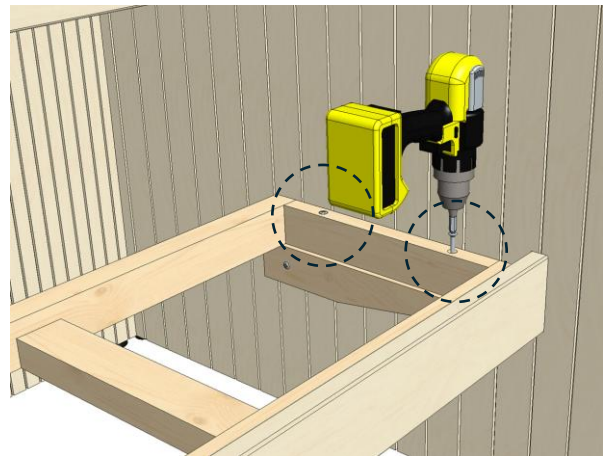
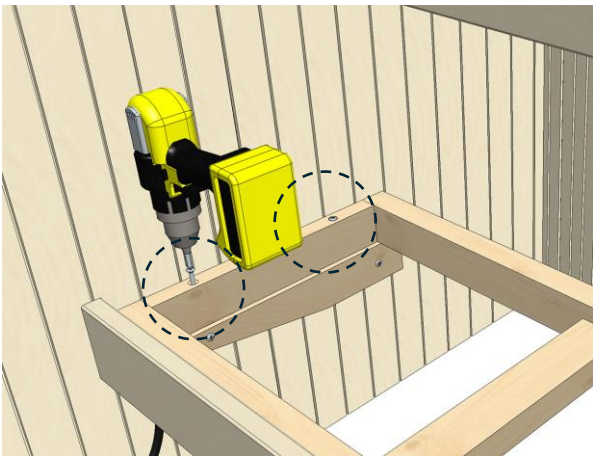
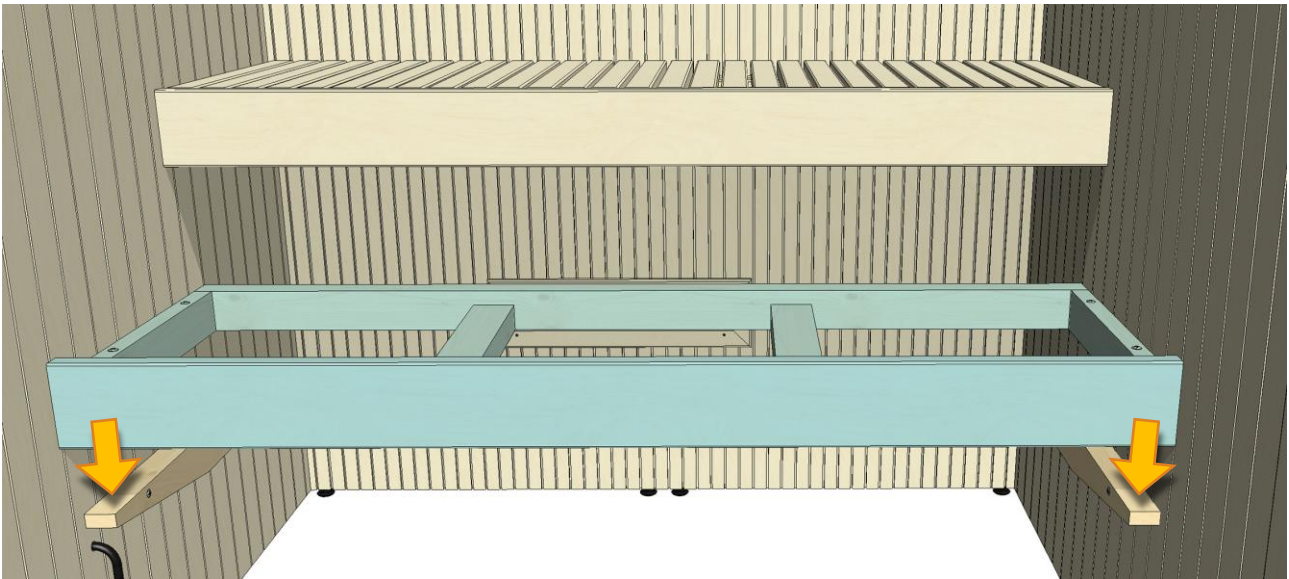

4 pcs Zn 5 * 80 mm

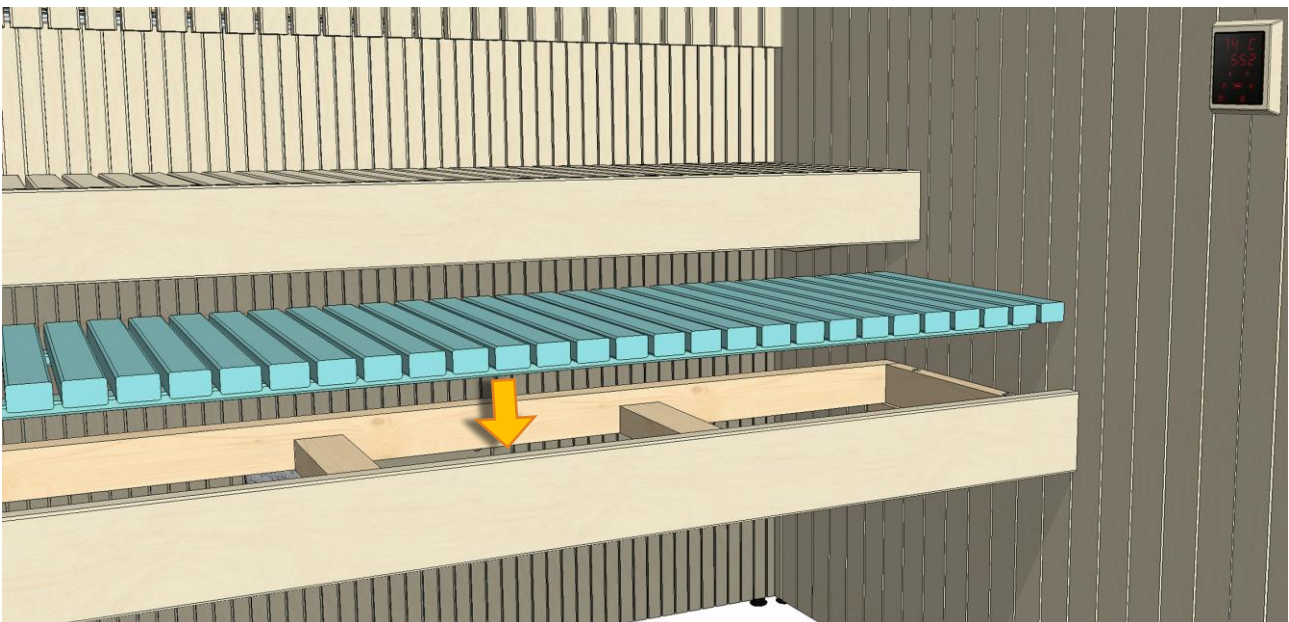

DOOR AND SIDE GLASS

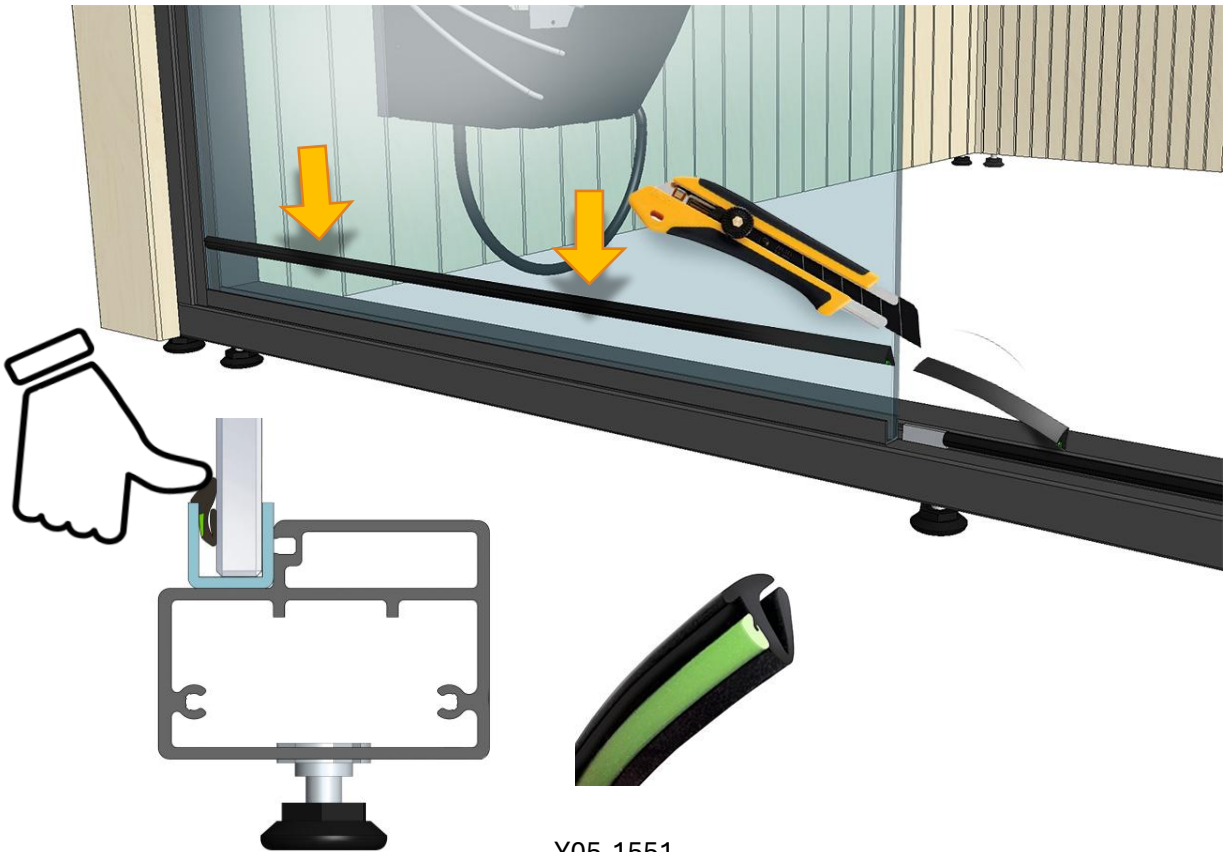
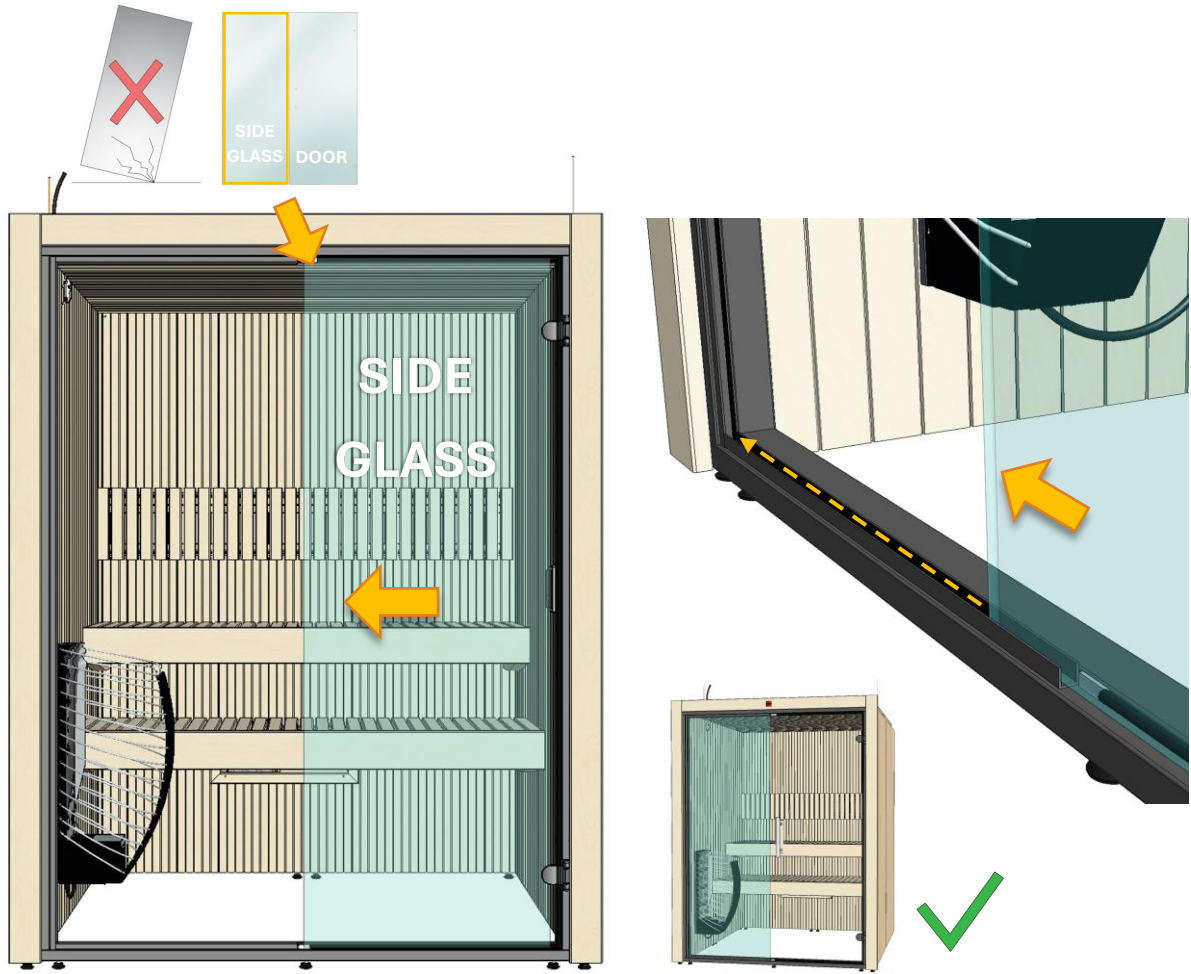

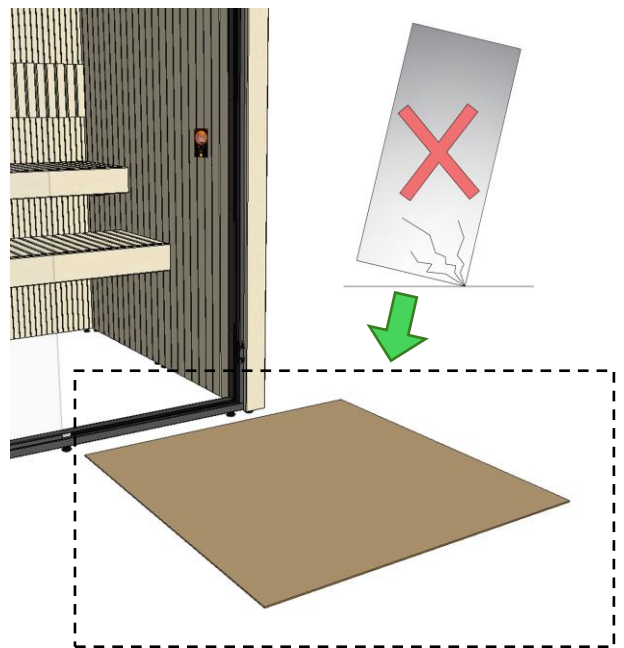
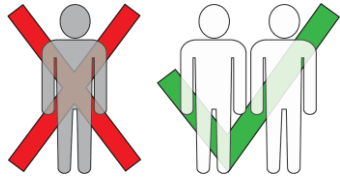
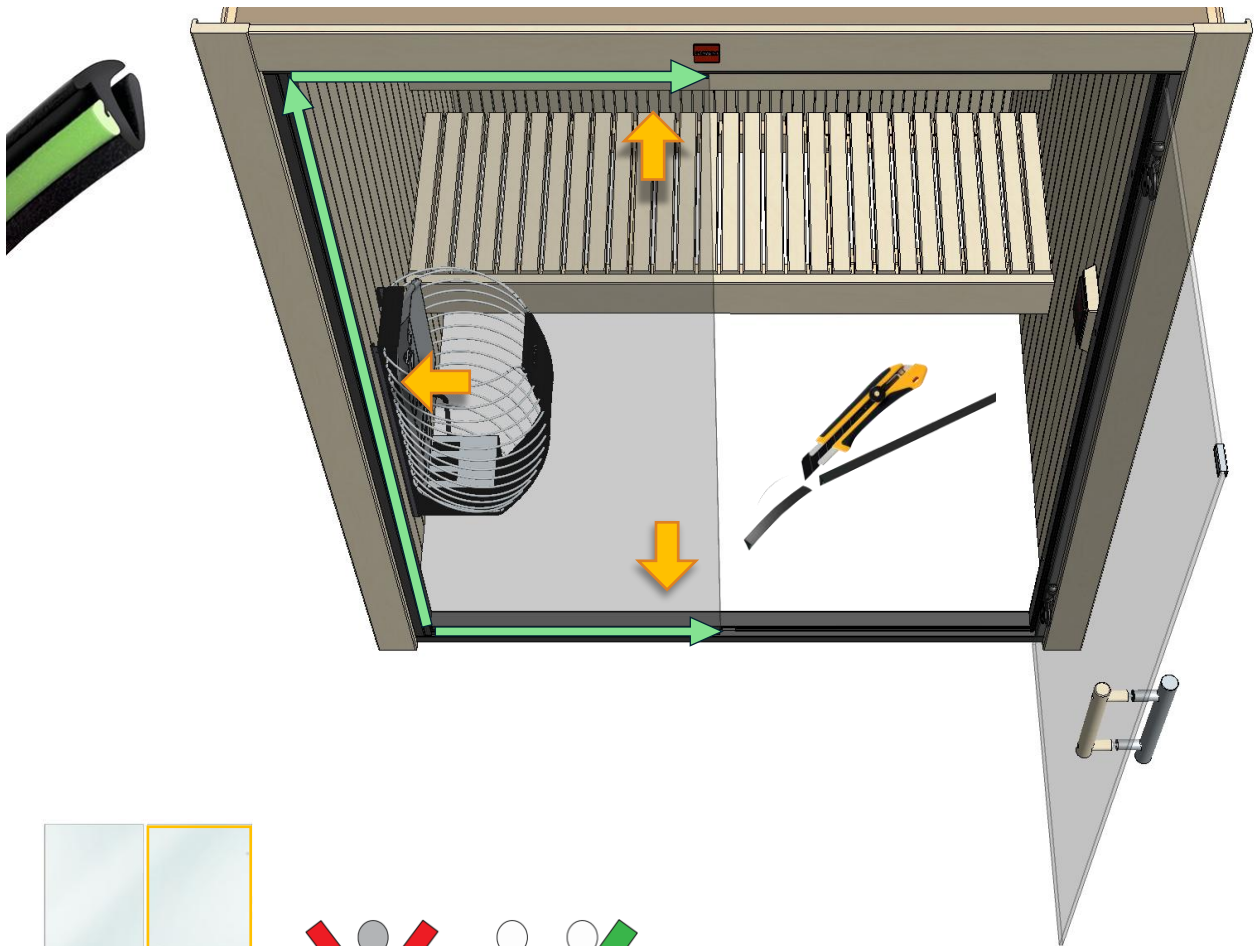

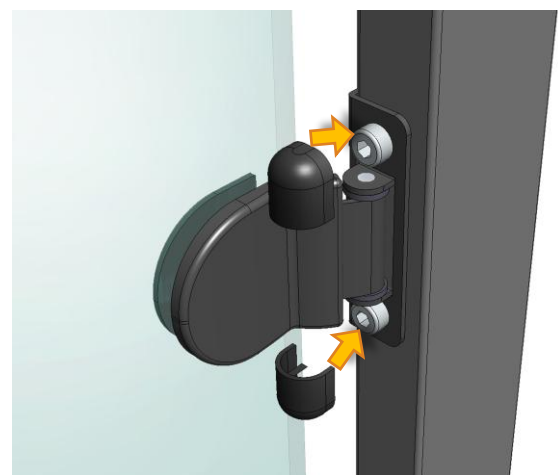
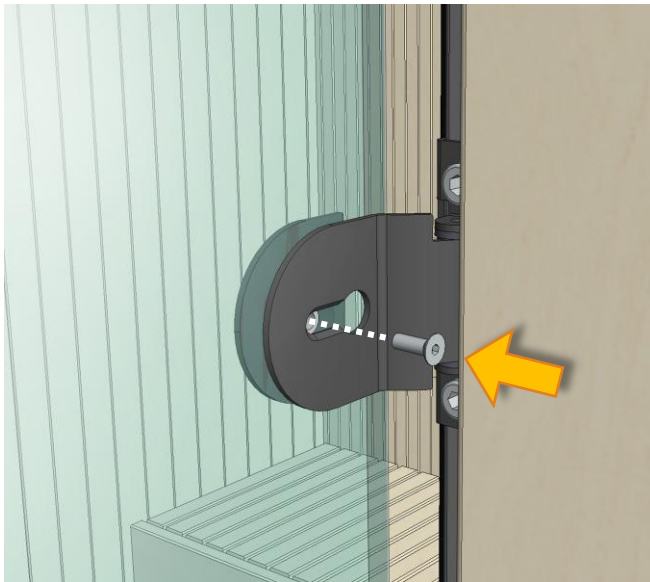
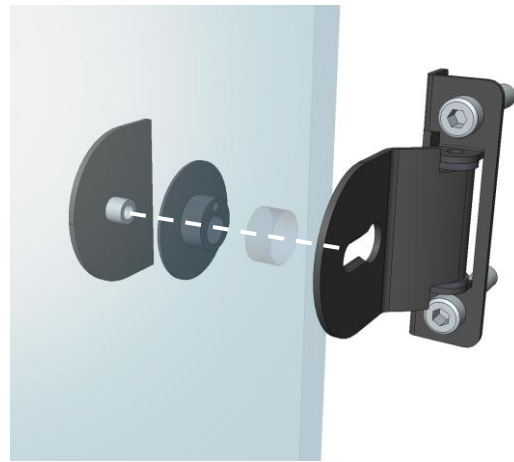
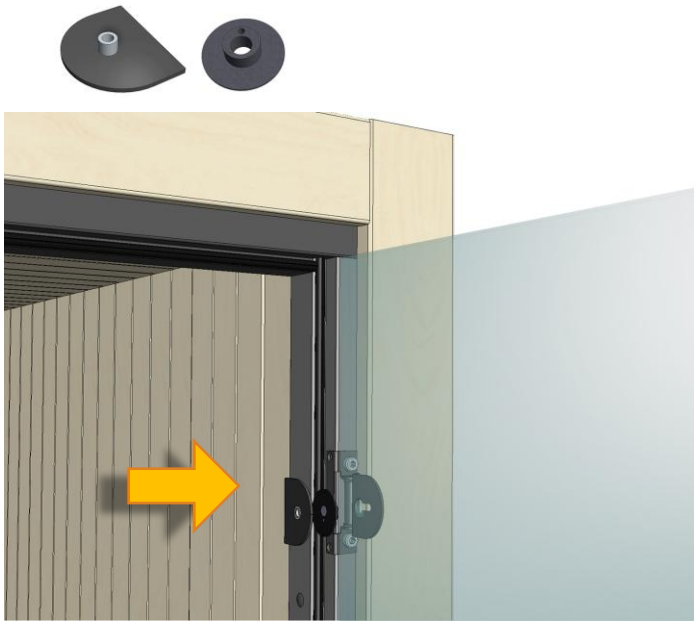

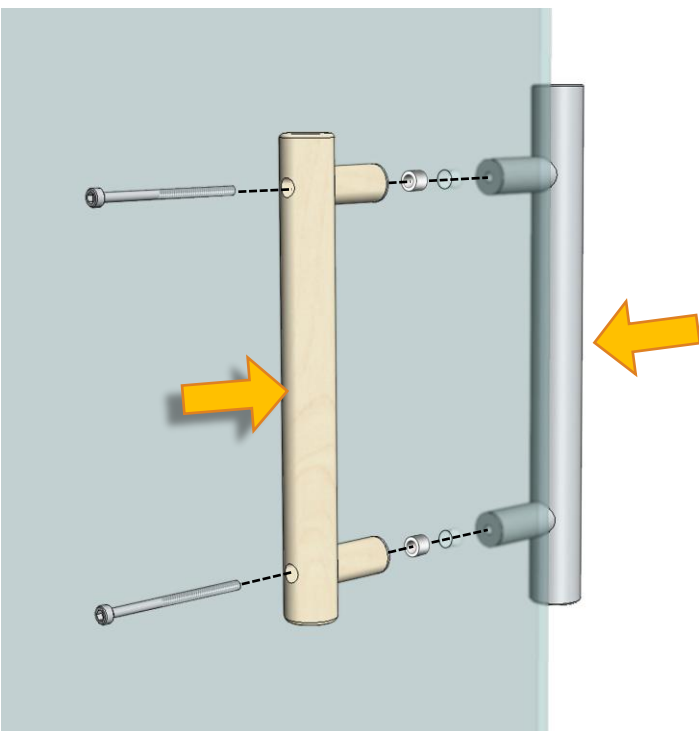
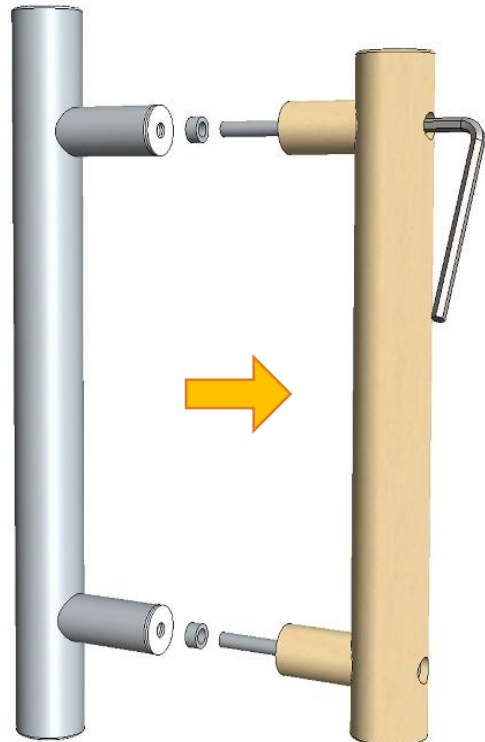
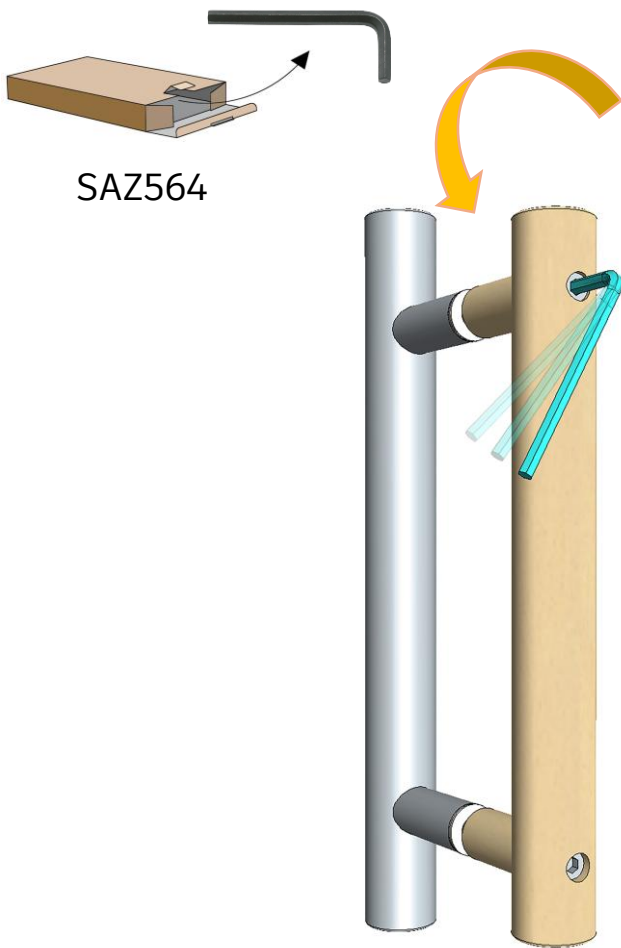

2 x ZVEL-259C

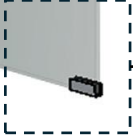

OUTSIDE GLASSES



Install the glasses in the order shown in the picture.

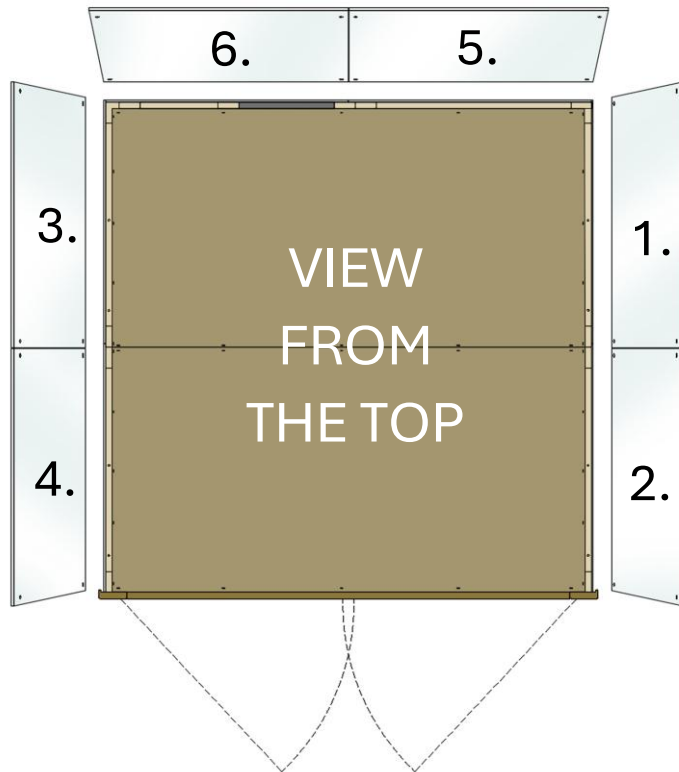

Start by installing 9 mm plywood pieces on the back wall!

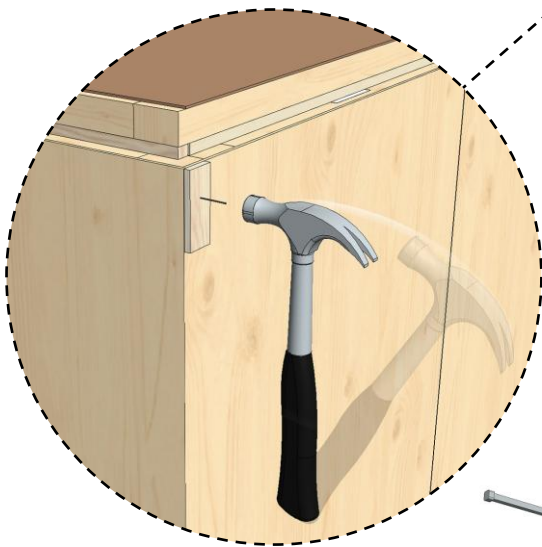

4 pcs Zn 1,7 * 45 mm



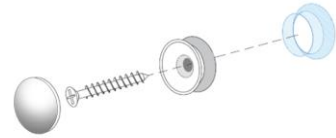
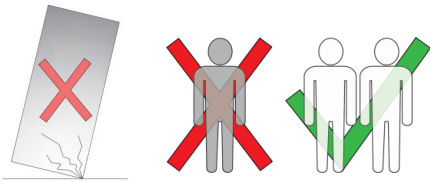

BO5206015 (URB1212 / URB1616)
BO5206011 (URW1212/URW1616)

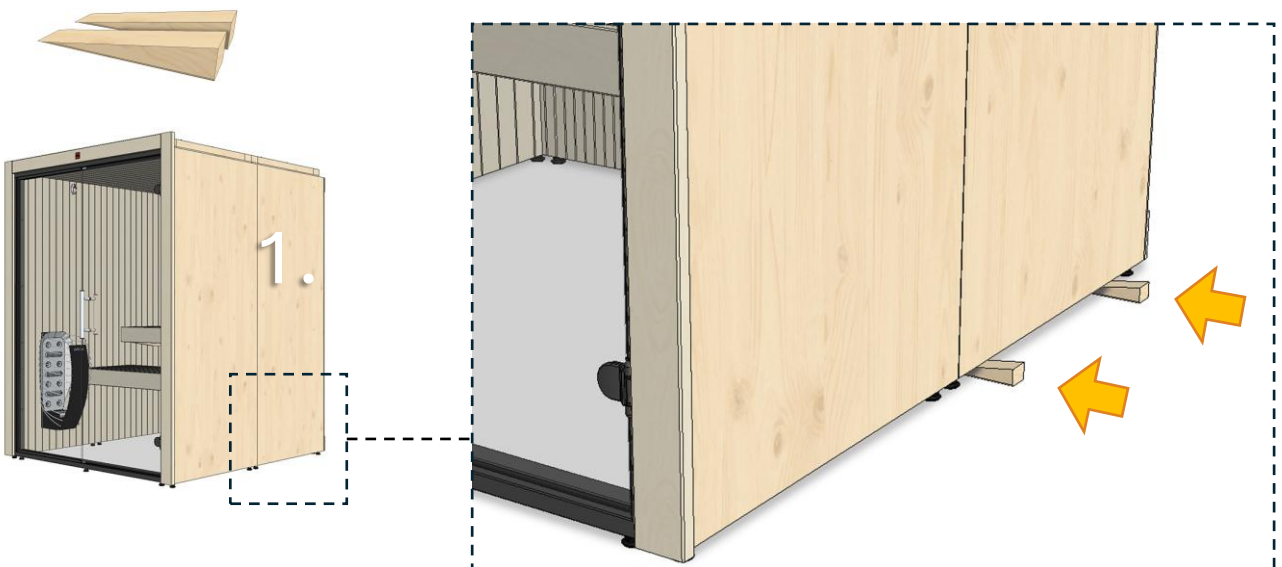
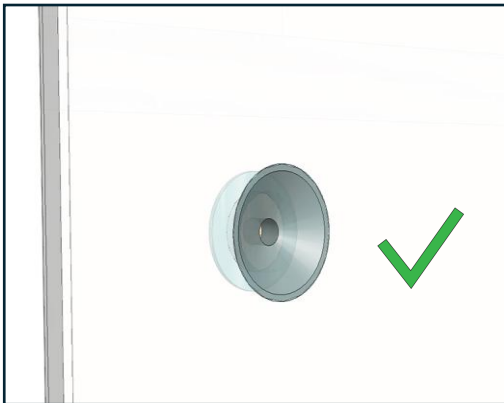
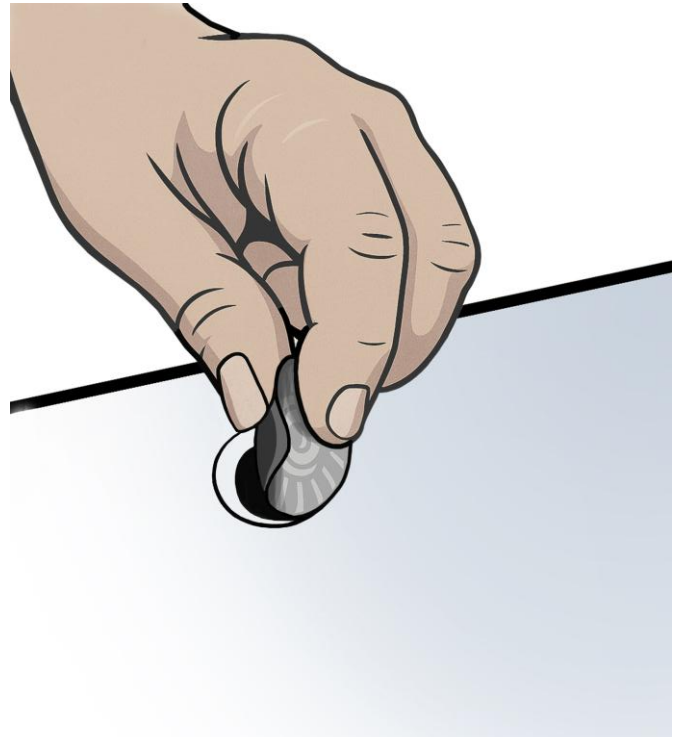

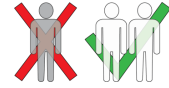

4 pcs Zn 4,5* 45 mm

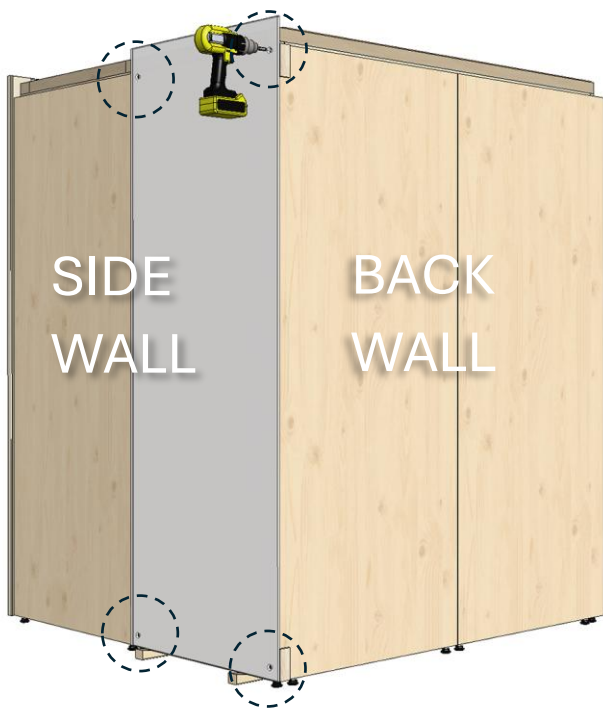

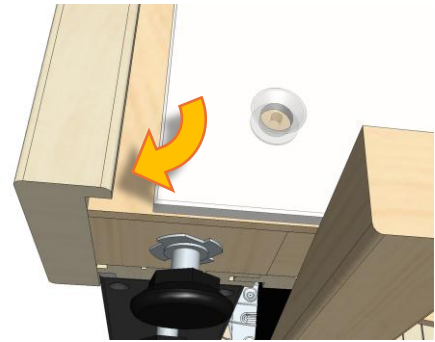
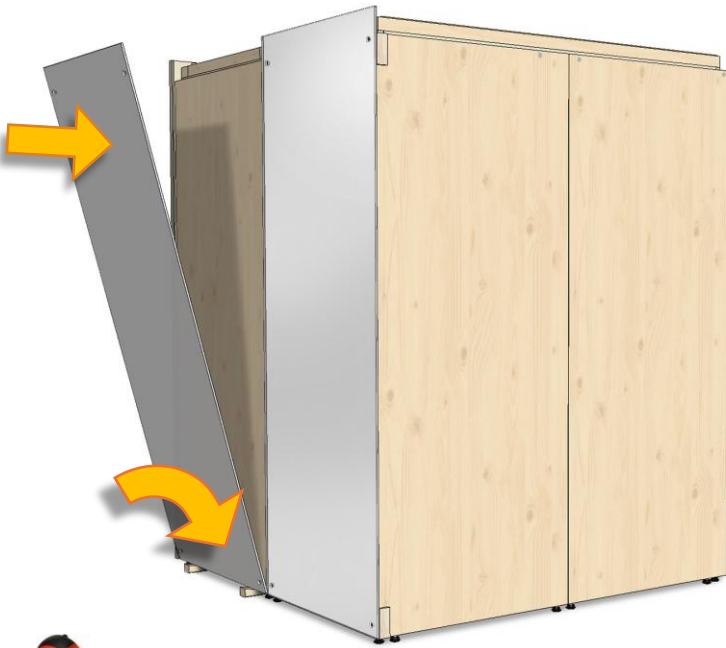
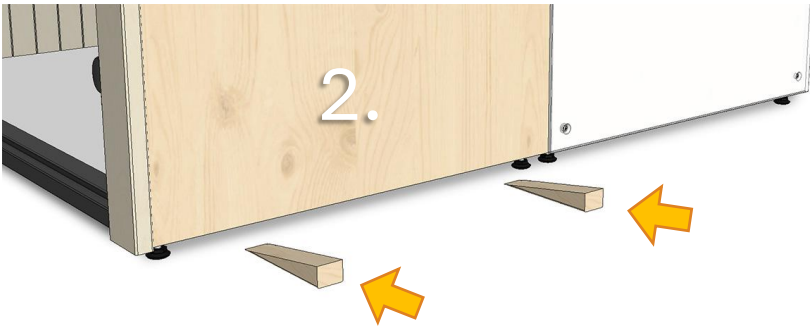



4 pcs Zn 4,5* 45 mm

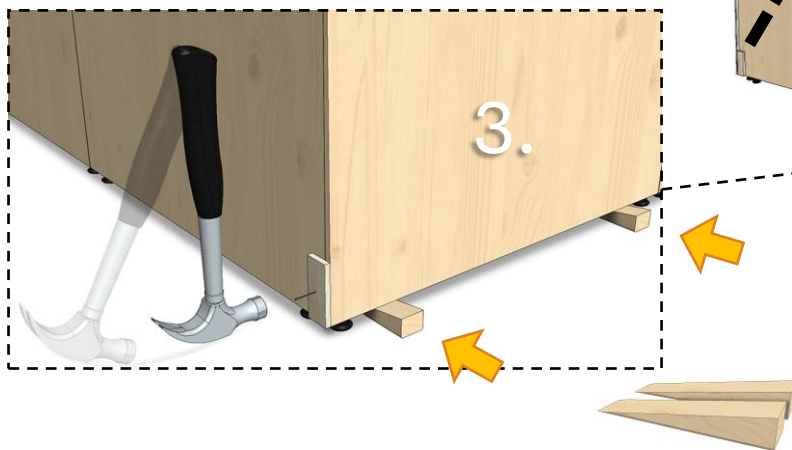
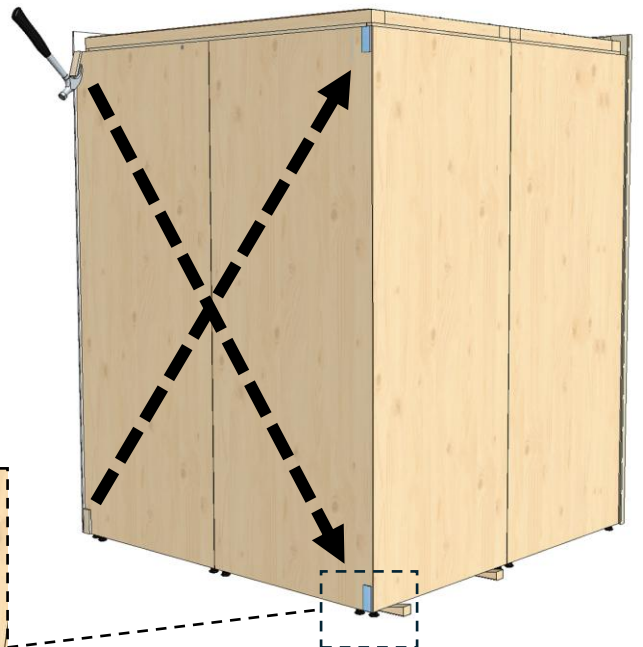

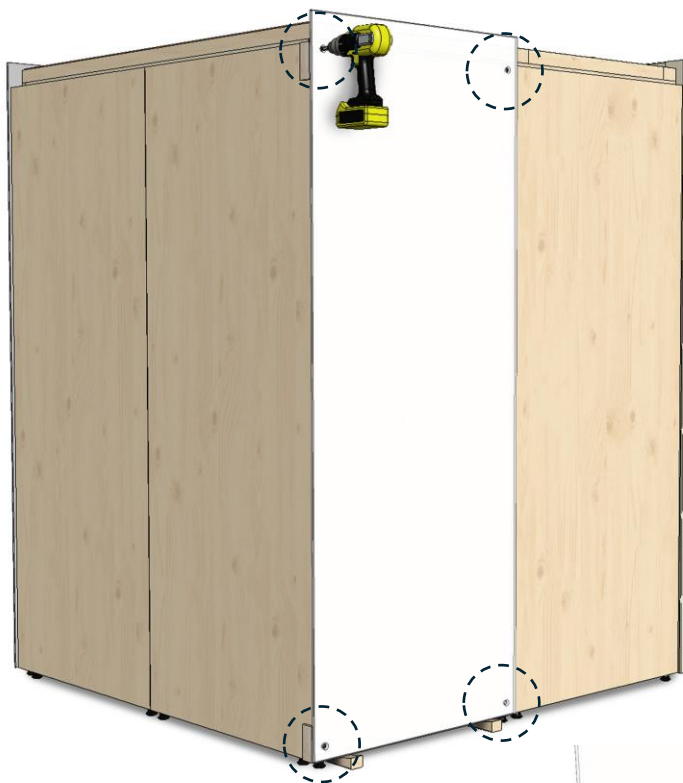
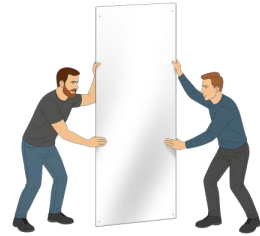
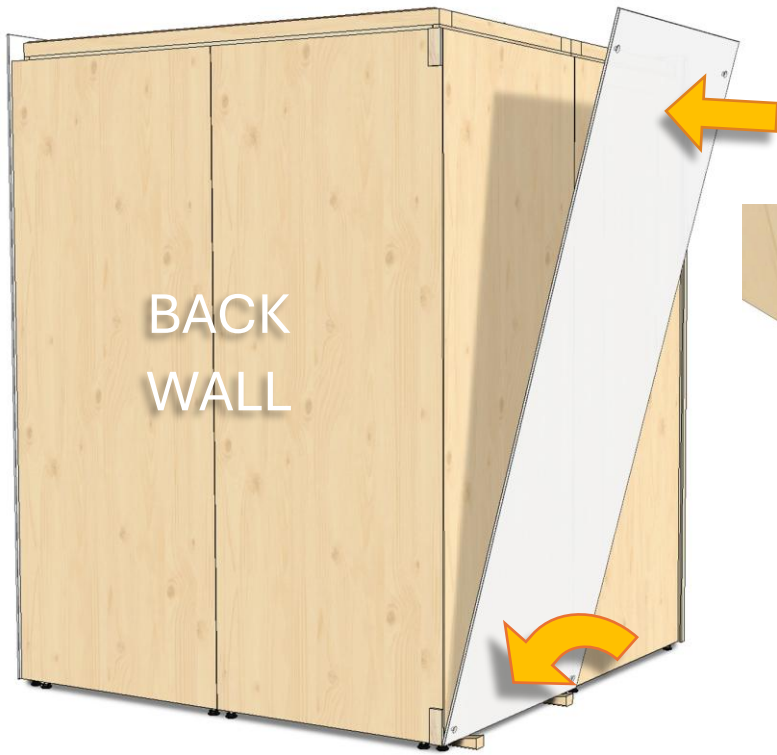

4 pcs Zn 4,5* 45 mm



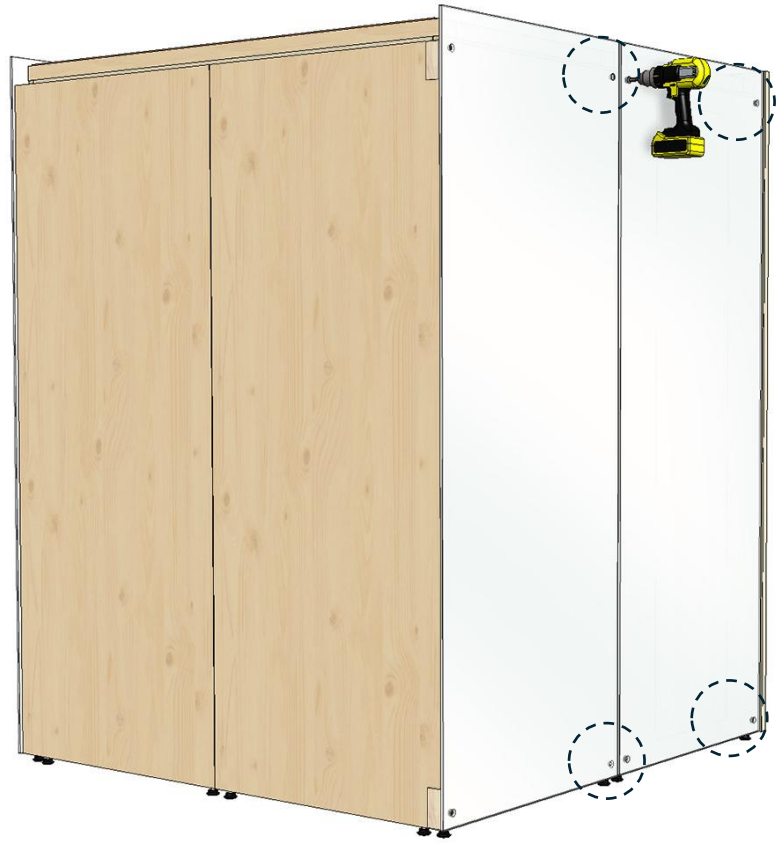
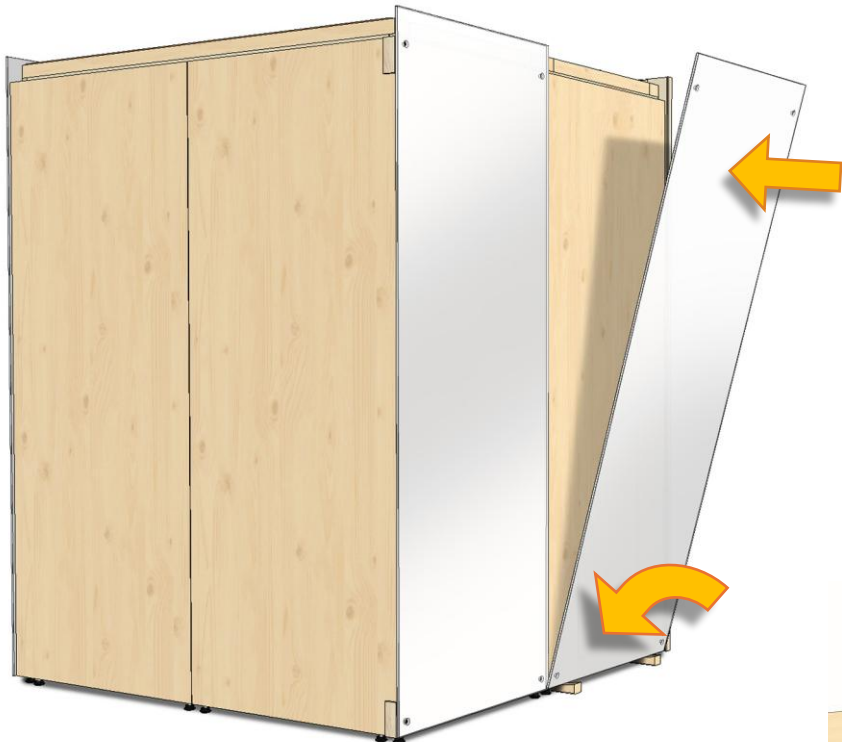

4 pcs Zn 4,5* 45 mm

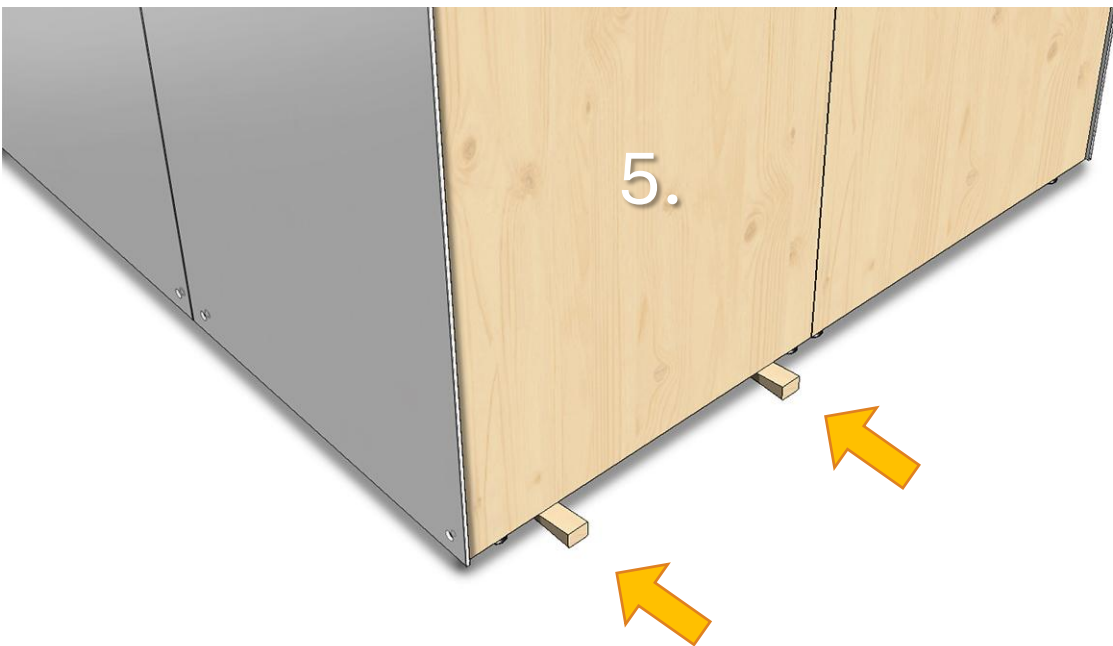
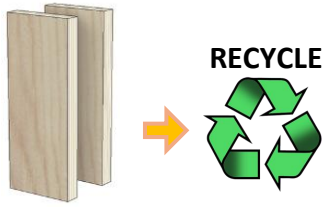

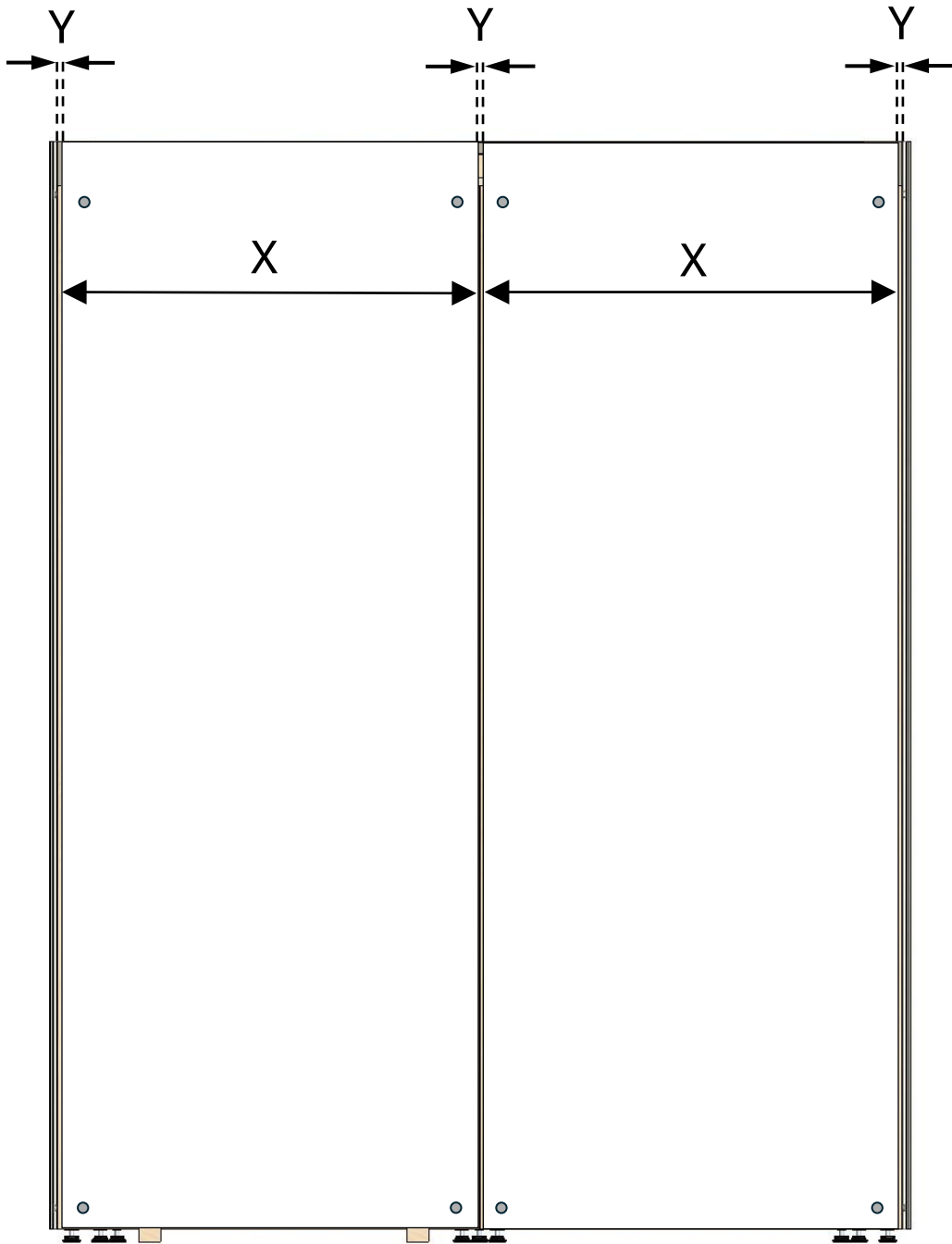
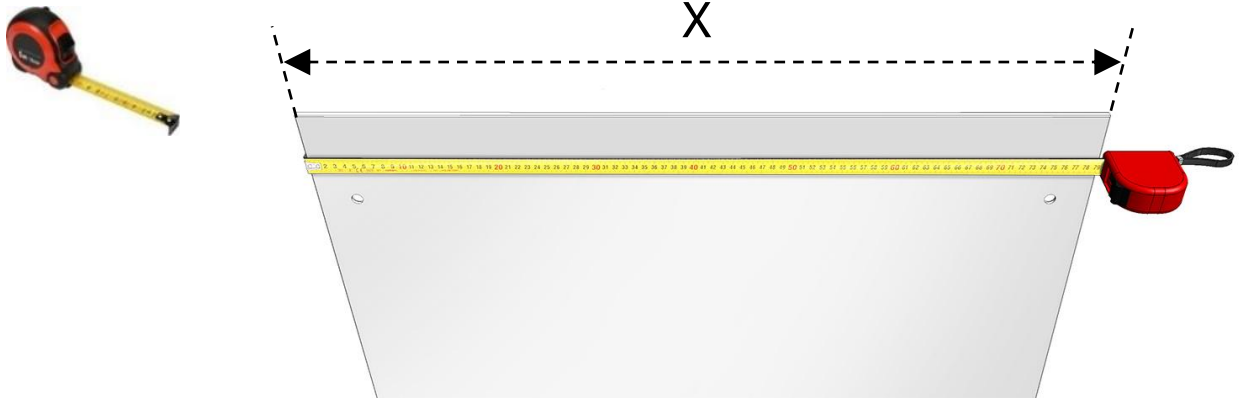

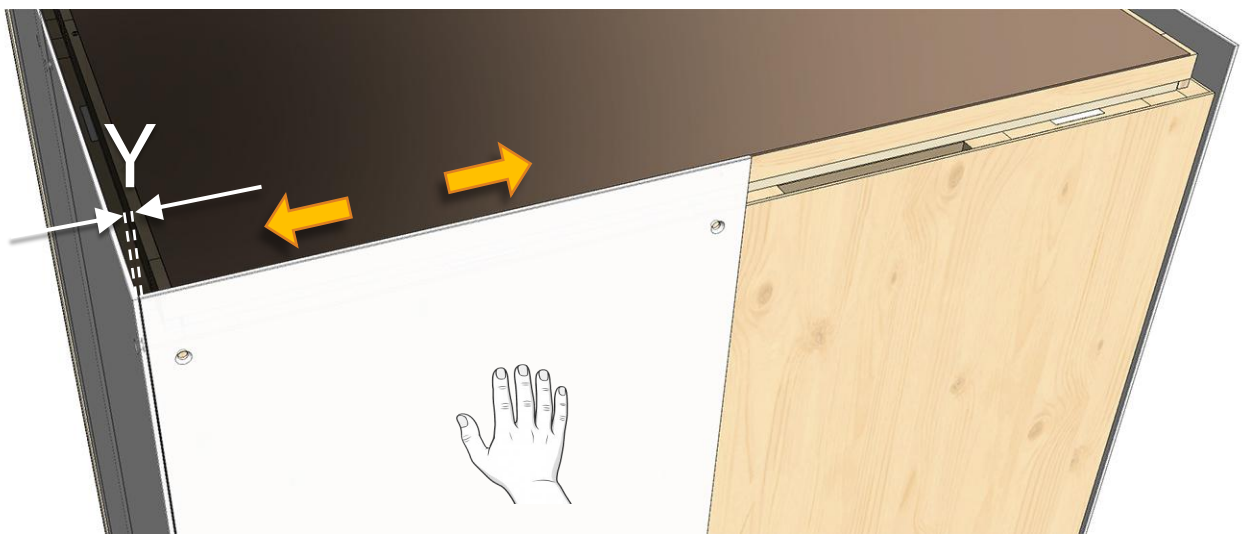
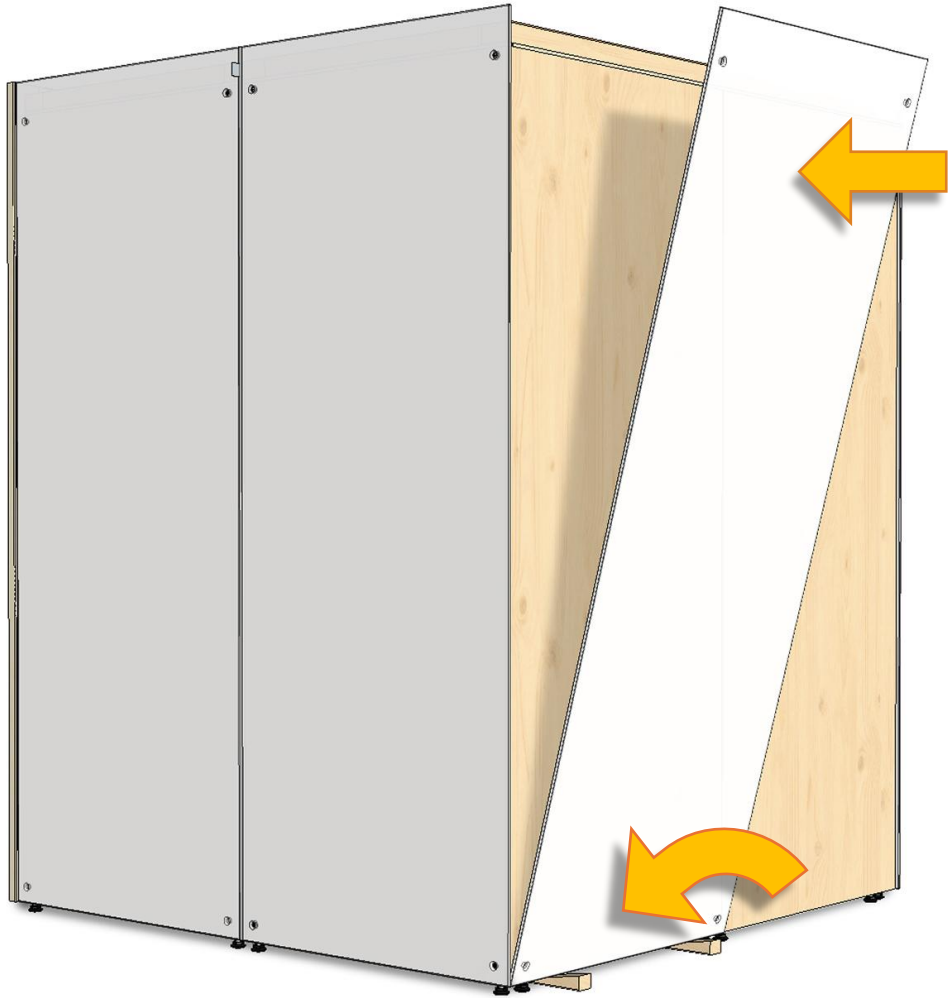

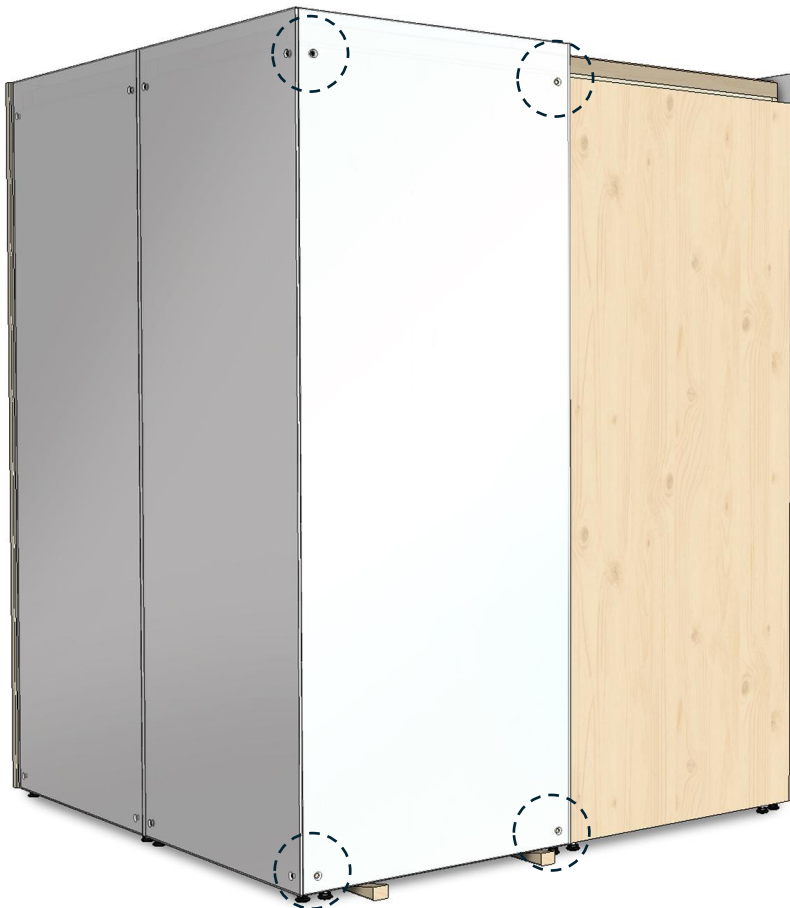
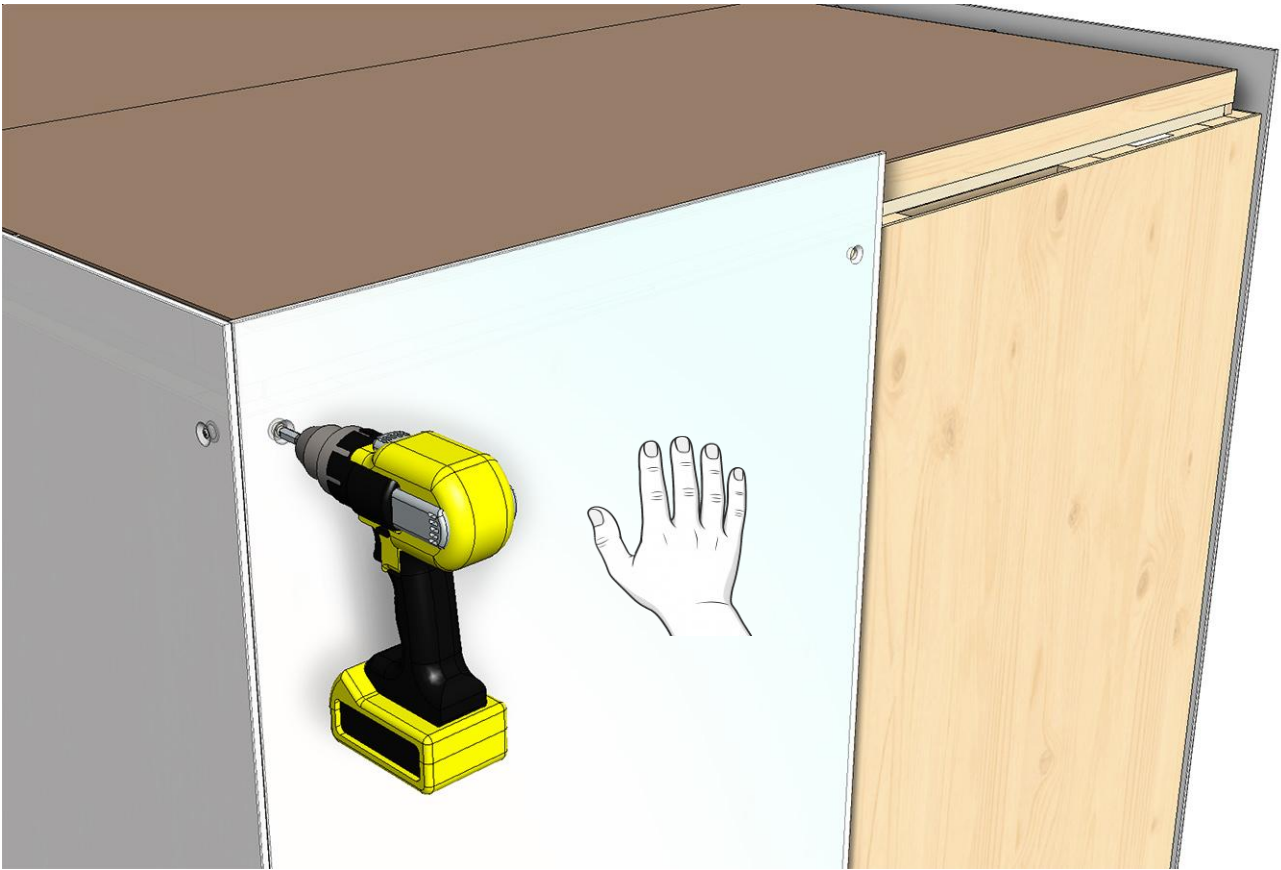

4 pcs Zn 4,5* 45 mm

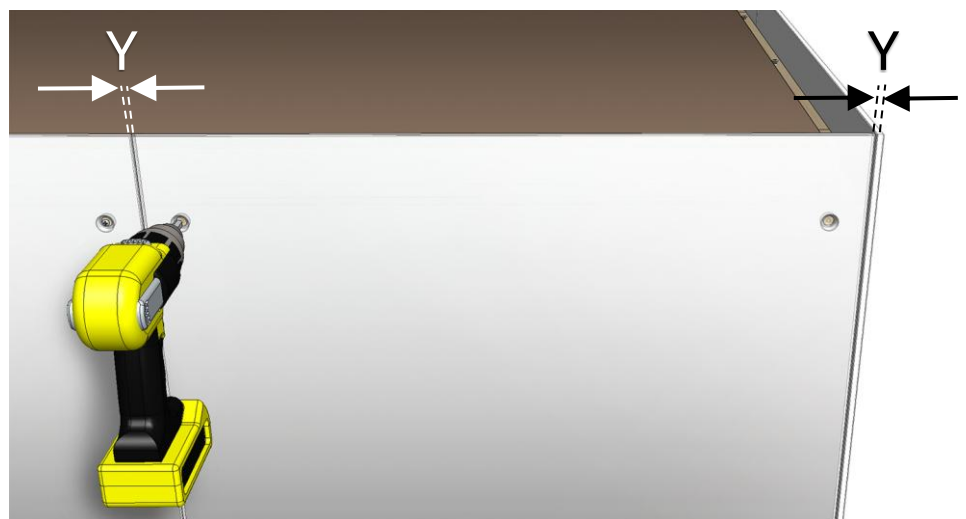

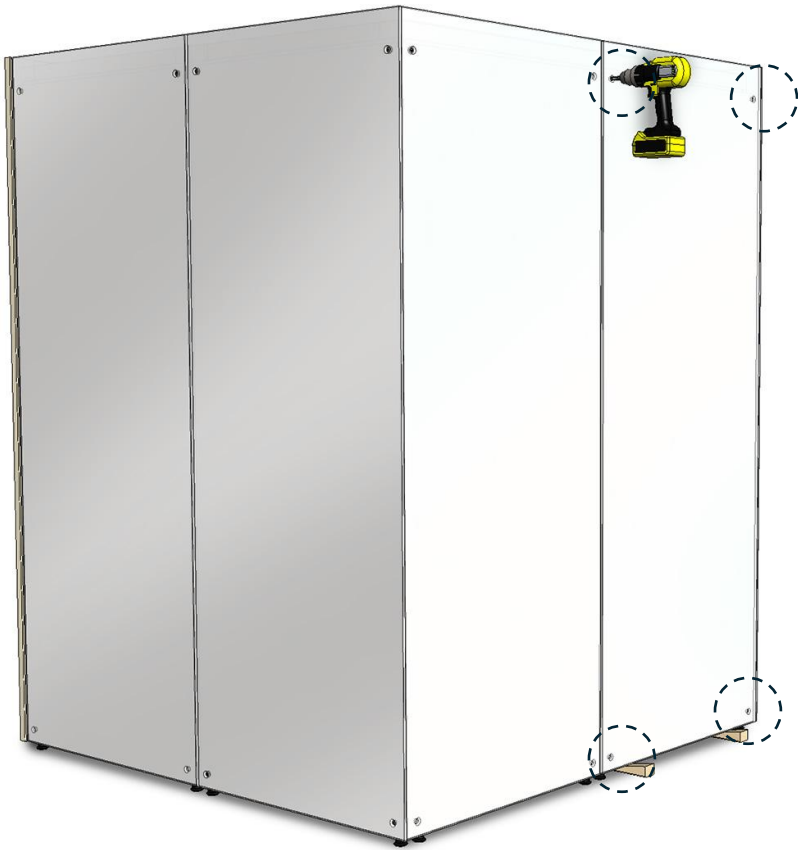

4 pcs Zn 4,5* 45 mm

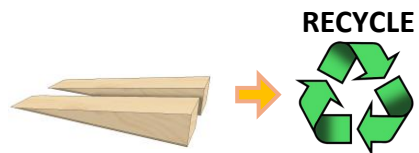

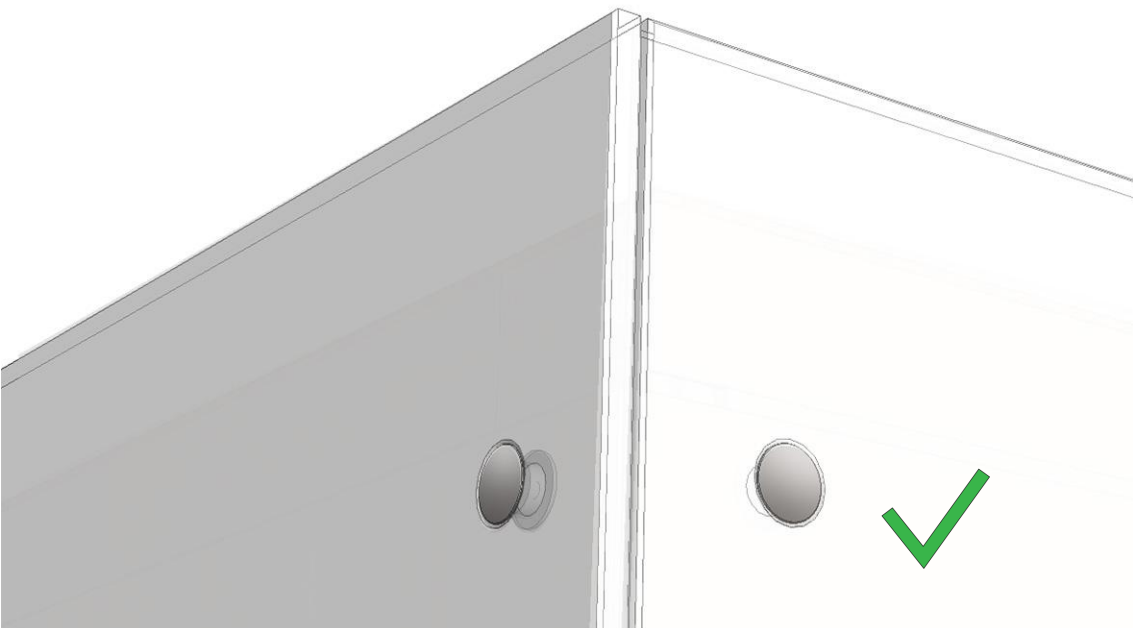
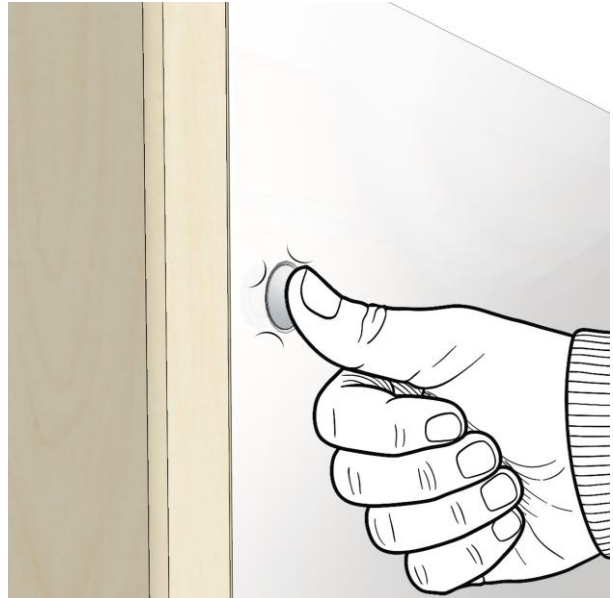
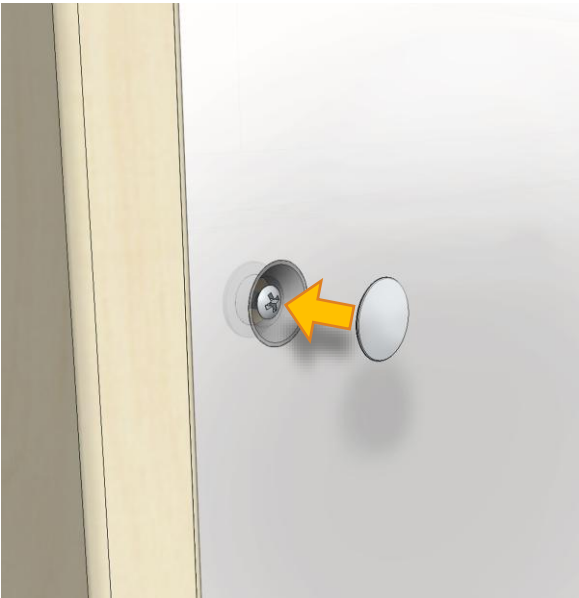
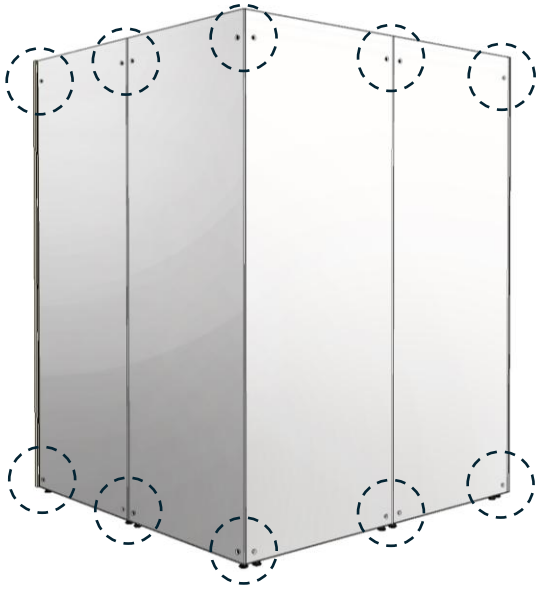



STONES



FI: & Klusakivien laittaminen	ES: & Colocación de las piedras
SV: & Ställning av baststenar	IT: & Come impilare le pietre della stufa
EN: & Piling of the Sauna Stones	FR: & Empilement des pierres de poêle
DE: & Einlegen der Steine	NL: & Saunastenen opstapelen



HEATER GUARD

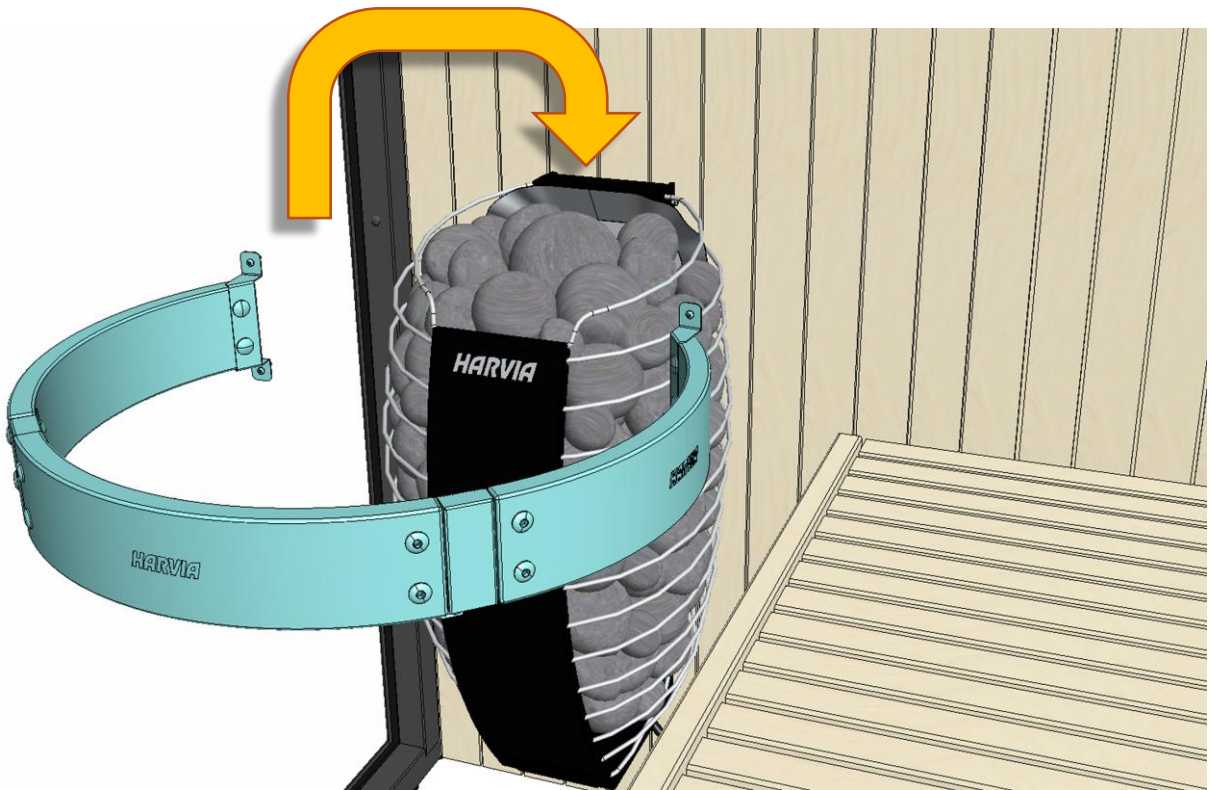
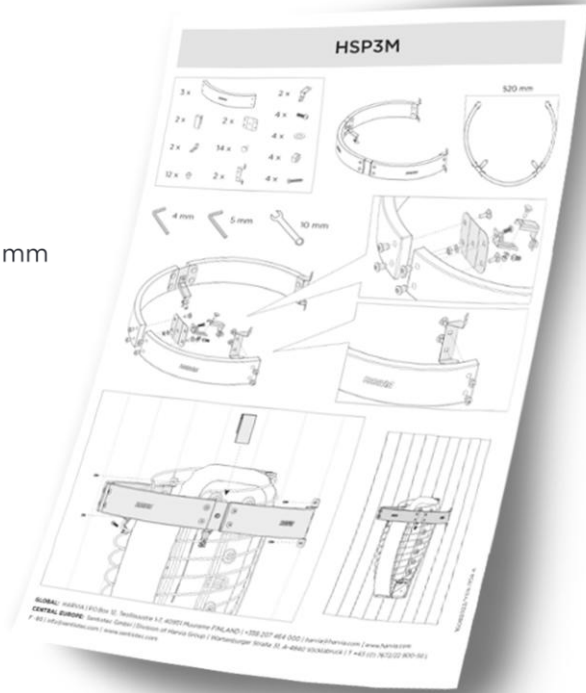
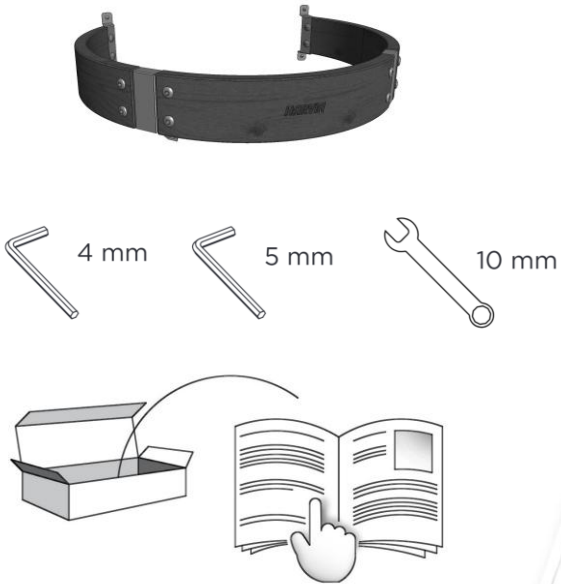

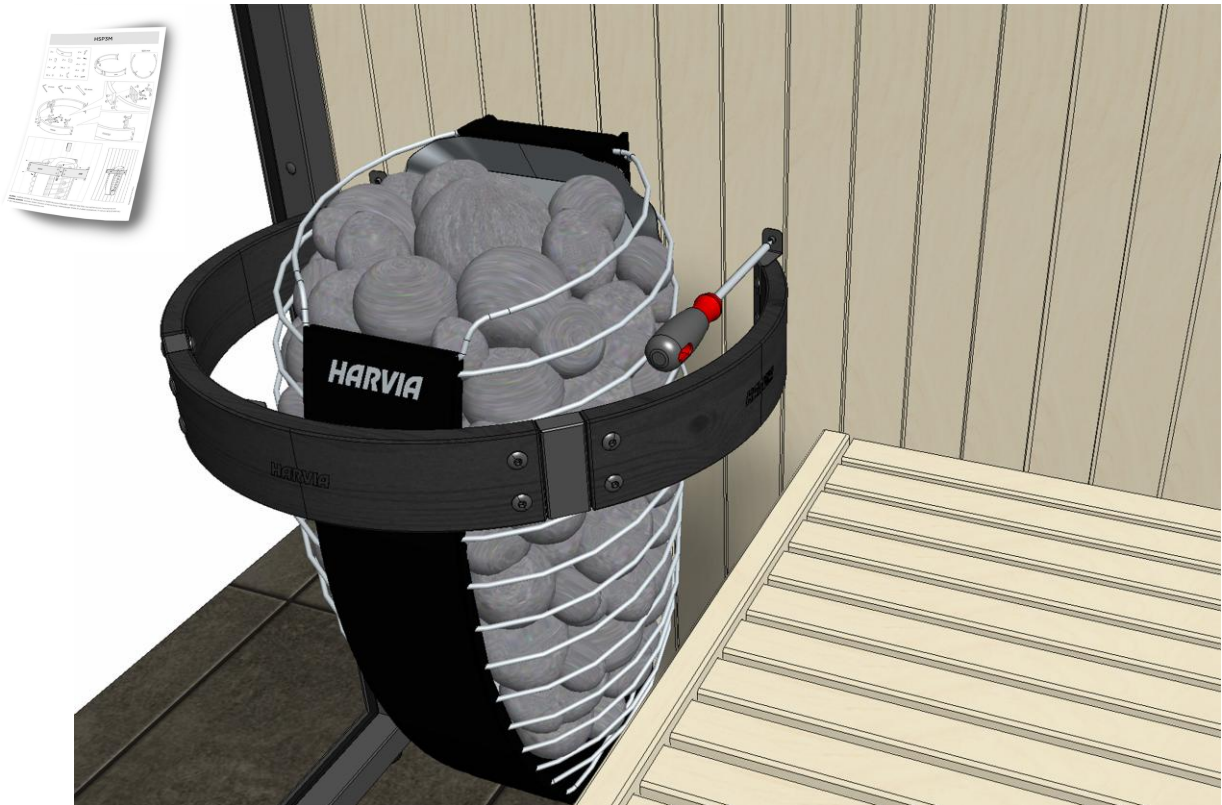

Spare parts:
spareparts.harvia.com

